

# HUMAN POWER

TECHNICAL JOURNAL OF THE IHPVA

ISSUE 33

## Contents of vol. 10, no. 2

Letters to the editor	
Corrections from Herb Treat	2
Help requested from China	2
Philip Thiel in Japan	2
Effects of crank-arm length. .	5
What is and what is not an HPV?	5
Response to Peter Sharp	5
Human power in agriculture	7
Editorials <i>Dave Wilson</i>	
Team Cheetah	3
Mike Burrows and Lotus	3
Contributions and timeliness	4
Suspensions	4
The Recumbent Cyclist & Cycling Science	4
Side-bar: regulating HPVs <i>Rob Price</i>	6
Profiles: Peter Ross	6
John Kingsbury	7
Reviews <i>Dave Wilson</i>	
British Human Power Club	7
hpv nieuws	13
Recumbent Cyclist RCM 13	18
Cycling Science, vol. 4/1	18
Cantilever wheel hubs <i>Mike Burrows,</i> <i>with introduction by Mike Eliasohn</i>	9
Triton vs Deep Purple <i>Cory R. Brandt</i> & <i>Doug R. Ackerman</i>	11
Short- vs long-wheelbase recumbents <i>Charles Brown &amp; Jon Stinson</i>	14
Rolling-resistance test of small wheels <i>Charles Brown</i>	15
Aerodynamic gains from cross-wind conditions <i>Tim Leier</i>	17
HPV news from Japan <i>Toshio Kataoka</i>	19

VOLUME 10

2

ISSUE

FALL-WINTER 1992-93

### Human Power

The technical journal of the  
International Human-Powered Vehicle  
Association

David Gordon Wilson, editor  
21 Winthrop Street  
Winchester, MA 01890-2851, USA  
Phones: 617-729-2203 (home)  
617-253-5121 (MIT)  
617-258-6149 (FAX)

#### Associate editors

**Toshio Kataoka, Japan**  
1-7-2-818 Hiranomiyama-Machi  
Hirano-ku, Osaka-shi, Japan 547

**Theodor Schmidt, Europe**  
Hoheweg 23  
CH-3626 Hunibach  
Switzerland

**Philip Thiel, watercraft**  
4720 7th Avenue, NE  
Seattle, WA 98105, USA  
**IHPVA**

P.O. Box 51255  
Indianapolis, IN 46251, USA  
Phone: 317-876-9478

#### Officers

Marti Daily, president and  
executive director  
Adam Englund, secretary  
Bruce Rosenstiel, treasurer  
Paul MacCready, int'l president  
Doug Milliken, VP water  
Glen Cole, VP land  
Chris Roper, VP air  
Matteo Martignoni, VP ATV  
Theodor Schmidt, VP hybrid power

#### Board members

Allan Abbott  
Marti Daily  
Peter Ernst  
Dave Kennedy  
Chet Kyle  
Gardner Martin  
Gaylord Hill  
Dennis Taves  
David Gordon Wilson

*Human Power* is published quarterly by the International Human-Powered Vehicle Assoc., Inc., a nonprofit organization devoted to the study and application of human muscular potential to propel craft through the air, in and on the water and on land. Membership information is available by sending a self-addressed stamped business-sized envelope to the IHPVA address above.

Additional copies of *Human Power* may be purchased by members for \$3.50 each, and by nonmembers for \$5.00 each.

Material in *Human Power* is copyrighted by the IHPVA. Unless copyrighted also by the author(s), complete articles or representative excerpts may be published elsewhere if full credit to the author(s) and the IHPVA is prominently given.

We are indebted to the authors, to Marti Daily and to Maggie Beucler, whose dedicated help made this issue possible.  
Dave Wilson

## Letters to the editor

### Corrections from Herb Treat

Thanks for the copies of HP 10/1 with my article [on wind-noise reducers for helmets]. It has already produced one phone call, from someone in NYC who is about to market a similar device.

There was an omission in equation (2), which should read:

$$u[i]'(RMS) = \left\{ \sum_{i=1}^N (u[i] - \bar{u})^2 / N \right\}^{1/2} \quad (2)$$

And references 3, 4 & 5 were omitted:

3. Lighthill, M.J. (1961) On sound generated aerodynamically (Bakerian lecture). Proc. Roy. Soc. vol. 267 pp 147-182, London, UK.
4. Parker, J.D., J. H. Boggs and E.F. Blick (1969). Introduction to fluid mechanics and heat transfer. Addison-Wesley, Reading, MA
5. Interested readers can experience the effect of these devices in the following manner. Place your head a few inches in front of an ordinary household fan. Facing into the wind, position your head so that the wind-noise, as distinguished from the fan noise, is audible. Then place your extended index fingers against the sides of your head immediately in front of your ears. The level of wind-noise will drop appreciably.

Please note my new address - I am now professor emeritus.  
C. H. Treat, 6310 Mahabo Drive  
San Antonio, TX 78218-4318;  
phone: (210) 655-0030

### Help requested from China

I am pleased to send you some photographs and two documents about my land-skates. I should be most obliged if you would give me any information about land-skates in the USA.

I have to work for my living, so that I have little time for my land-skates.

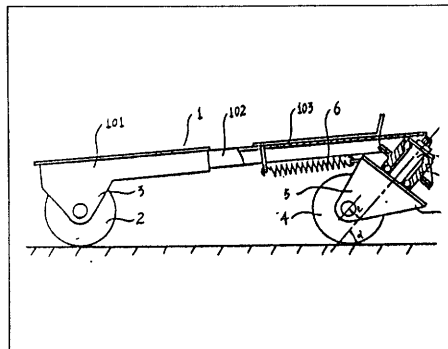

With very good wishes for a happy Christmas and a bright new year.  
Yanben Guo, 4/F 10 LingXiaoLi, Yuehua Road, Guanzhou P.B. 510030, China

(Yanben Guo sent some photos, diagrams and a patent for two- and three-wheel "land-skates" incorporating steering. I sent some bike-store-catalog pages of roller-blades. Any readers that can help by sending more information would be appreciated - DGW)

### Philip Thiel in Japan

(Phil Thiel, our associate editor for watercraft, has been teaching at the Sapporo School of the Arts. He has also sent delightful occasional essays. Here are a few short extracts from one recently received).

Sapporo, Japan's third-largest city (in area) and fifth-largest (in population) is located on the western plains of Hokkaido, the northernmost island of Japan. . . The Sapporo School of the Arts . . . opened in early 1991 with its first intake of 80 students. . . The director of the school is Kiyoshi Seike, one of Japan's architects most noted for his undocri-naire approach to design and his gentle humanism. His of my age, and we have known each other for 40 years, over which period of time we have taught in each other's schools, and exchanged children. . . I have been participating in and rehearsing for three ceremonies: welcoming the new students; the opening of the new year; and the opening of the recently-completed library. These are programmed on a moment-by-moment schedule, and all participants are carefully drilled in their parts, step-by-step, not without a good amount of humor and joking. As the token *gaijin* or foreigner, I am somewhat prominent, and sit on the right hand of the director (literally, in the case of the inevitable group photograph). . . At the end of the first week the faculty held a party for the new members in a basement restaurant near the city center. About 30 people filled the low-ceilinged space, which, after several "*compais*", seemed almost solid with smoke, jokes, impromptu speeches, and roars of laughter. . . ."  
(Phil also sent some news of human-powered developments, but in Britain: two chaps in Lancashire who converted a 7-m cabin cruiser to pedal drive using a built-up paddle wheel. They reported that it wasn't fast - about 1 m/s - but it didn't erode the canal banks).

Letters continued on p. 5

# HUMAN POWER

The technical journal of the IHPVA

Vol. 10, no. 2

Fall-winter 1992-93

\$5.00

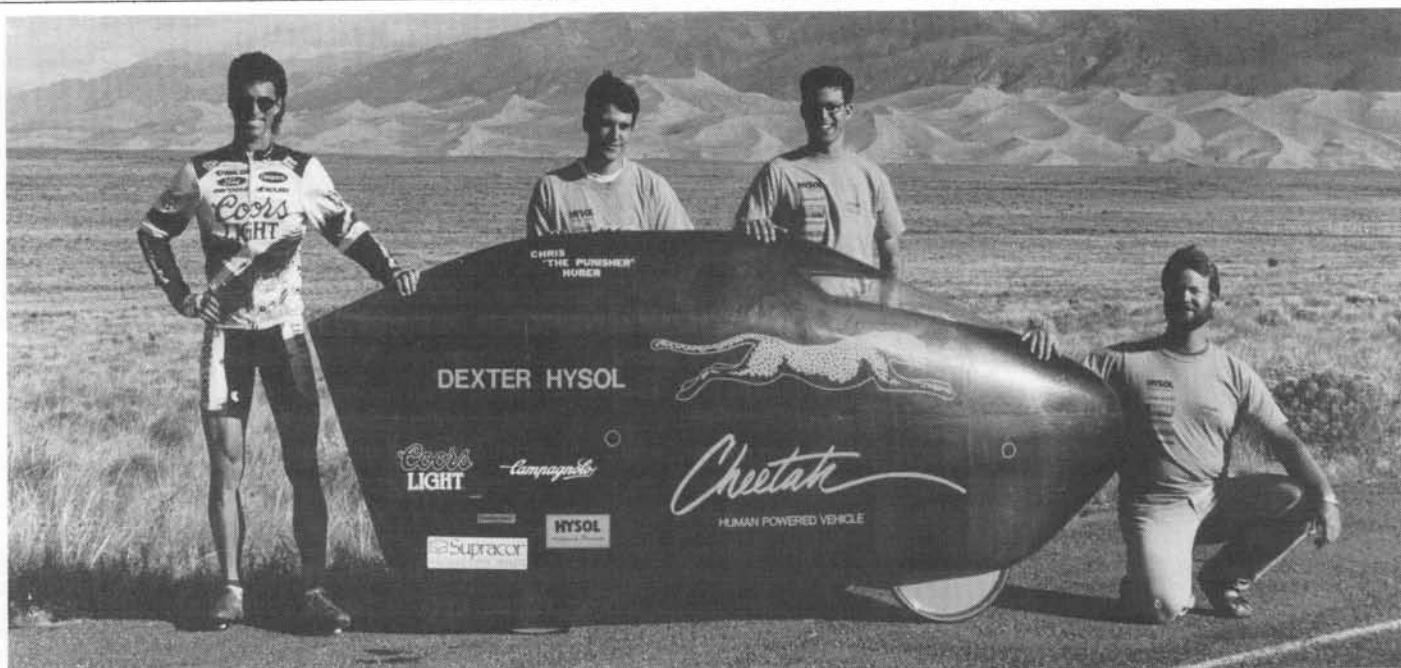

The Cheetah team on September 23 1992 in the Great Sand Dunes National Park, the day after they broke the land-speed 200-m flying-start record at 68.73 mph, 30.72 m/s. From L to R: Chris Huber, professional cyclist; Jon Garbarino, Kevin Frantz, and James Osborn, formerly UC Berkeley mechanical-engineering undergraduates

## 200-m flying-start record falls!

## Amazing performance by team Cheetah

### Editorials

#### Team Cheetah

In the early days of the IHPVA records were being broken regularly. What was more remarkable was that the speeds for the 200-m flying-start records were rising approximately linearly. That rate of rise had to come to an end. The winning in 1986 of the coveted Du Pont prize for a speed of over 65 mph by Gardner Martin's Gold Rush ridden by "Fast Freddy" Markham was expected to signal the coming of an era when, if the record were raised at all, it would go up by the minimum legal increment. But on September 22, 1992, the Cheetah,

powered by Chris Huber of the Coors Light racing team, went through a 200-m course in the San Luis Valley, Colorado, at 68.73 mph, 30.72 m/s. This is truly a remarkable record. If it were accomplished in the same vehicle and conditions as for the Gold Rush record it would require almost 16-percent more power. Kevin Frantz of Team Cheetah has sent me the accompanying photos, and has promised me a later article on the technical advances that allowed this increase in performance. (The team started as a group of U.C. Berkeley mechanical-engineering undergraduates including, besides Kevin Frantz, Jon Garbarino and James Osborn). Hearty congratulations on an amazing feat!

#### Mike Burrows & Lotus

The record set by Chris Boardman in qualifying for the 4000-m pursuit in the Barcelona Olympics in 1992 is equally remarkable, given the long history of this event and the small incremental increases in recent records set, as one would expect, at longer and longer intervals. The relatively huge increase in speed was achieved largely through improved aerodynamics in a beautiful bicycle designed, developed and made mainly by one of our own: Mike Burrows. Mike is chairman and press secretary of the British Human Power Club and producer of such race-winning HPVs as the Windcheetah and the Speedy. The "regular" bike he has been developing has a monocoque carbon-fiber frame and single-blade forks with, consequently, cantilevered wheel spindles. Mike had seen these used on an 1890s bicycle, which started his creative juices flowing. He has brought

*Continued on p. 4*

successively more sophisticated versions of the bike to the IHPSCs and other meets. I confess that I admired his creativity and his craftsmanship but I was skeptical about the concept. I felt that one would need larger, heavier spindles and very stiff forks to handle the off-center loads, and the bearings would need to be of a larger diameter than for the usual trussed forks. I am fearful enough of front-fork failures that a single-bladed fork seemed to be tempting fate. How much one can be convinced by a demonstration of complete success! This skeptic has been converted into a humbled admirer. Mike Eliasohn has invited Mike Burrows to contribute to an article that you will find in this issue and that you should find very informative.

Two notes about this development should be made. One is that in one or two articles in other publications about the Lotus Sport, Burrows has been given very little credit. Our Doug Milliken has documented Mike's contributions and has written to one or two authors and publishers to set the record straight. Not giving credit to someone, whether for an illustration or an invention, is truly short-sighted selfishness, because the deception is (almost) bound to be laid open to all. We appreciate Doug Milliken's actions. The second point is that, sadly, Mike Burrows felt that he had to resign from the IHPVA board in protest a few years ago because he felt that our organization does not live up to the "international" in its title. We should not lose people of his caliber. No man is an island, and likewise no organization can be an island and stay successful.

### Contributions and timeliness

This issue of Human Power is late. Part of the reason is that getting an issue out takes steady effort at a low level for months and then a push using most of my evenings and weekends for several weeks. During an average school semester I don't have evenings or weekends free, so that an issue has to wait a break between semesters. But another reason for lateness is that very few contributions have come in. I solicit articles and papers from people whose topics I think will be informative and enjoyable, and about a quarter of the people I contact respond. (Why not more? Some people promise articles repeatedly until I get tired of asking. Some just don't reply to invitations to write.) Sometimes a surge of voluntary contributions come

in. After Phil Thiel took on the editorship for an issue and asked for papers on watercraft, we had enough to spread over three issues. In fact, there were even complaints that HP had changed its focus too much in the watercraft direction. If you, dear reader, don't like anything about Human Power, do something about it! Write something or ask someone else to do so!

The leads to an introduction. While Ellen and I will be in New Zealand February-May 1993 (I've been invited to teach at the University of Canterbury, which happens to be where my father went to school) HP will have a super editor in the person of Patrick K. Poole, recently retired from the USN submarine service and from teaching at Annapolis. He will be soliciting papers especially from participants in the HP submarine races in Florida in June, 1993 - but there will undoubtedly be a wealth of other topics in his issues. His propeller paper in HP9/1/91/6 was the best-prepared contribution I have ever had for any publication. You will find that his standards are high. You and I are lucky to have such a volunteer.

### Suspensions

The principal bicycle magazines are featuring useful articles on suspensions (sprung-and-damped wheel systems.) We have had none. We would like to have some. Consider this an invitation to submit.

Suspension isn't as important to most HPVs as it is to mountain bikes. Here in New England we have had more snow this winter than for several years, and reluctantly I have had to leave my LWB recumbent, far better in the snow than my previous MWB and SWB machines, at home on several occasions. I used my old ten-speed with thin slick tires, and was again amazed how I could plow through drifts and recover repeatedly from front-wheel and rear-wheel skids. There are two reasons for this capability on the part of the "regular" bike: a high center of

gravity, so that one has time to recover from a skid; and the freedom it confers to use "body English" - one can throw one's weight in one direction and the bike in another to get out of difficulty. Most HPVs have low centers of gravity requiring response times much too short for the combination of human and machine to match; and they generally cradle the rider in a comfortable seat and backrest, from which wildly independent actions are impracticable. Hence, in my opinion, present types of HPVs are not going to challenge mountain bikes on rough stuff. If you disagree, write a letter or an article for us.

### The Recumbent Cyclist & Cycling Science

Usually I like to review at least the table of contents of *Cycling Science*, a technical journal founded by our Chet Kyle and by Ed Burke. (It has just been bought by Pike Creek Press and vol. 4/1 has been published). From this issue of HP I will try also to review *The Recumbent Cyclist*, founded, edited and published by Robert J. Bryant with the considerable help of his wife Marilyn. It is given mainly to road tests of recumbent bikes and trikes in which Bob is always pretty positive, but reveals important characteristics through subtle mentions or non-mentions. There are also a few technical articles. Until HPV News 9/6 came out I found better information on Team Cheetah in "RCM" than elsewhere. The magazine is expanding and maturing, and the Bryants are to be congratulated. They have undoubtedly won many converts to the recumbent movement.

*Dave Wilson*



*Chris Huber on the basic Cheetah recumbent bicycle*

Letters continued from p. 2

## Effects of crank-arm length on physiological response in arm ergometry (HP 10/1/91/19)

(This is a comment on the paper by Brent Gravelle and Richard Powell.) Good work - but why the constant-rpm restriction? Of course cranking hand speed is higher for longer cranks at constant rpm. What if you chose constant hand speed instead? Higher rpm with a shorter crank or lower rpm with a long crank may be the ticket. This opens a new can of worms but you don't have to make new cranks; you appear to have the facilities to do good work; and those who may benefit from your work may greatly appreciate it. Please continue it.

Mark Knaebe, 4026 Euclid Avenue,  
Madison, WI 53711, USA

## What is and what is not a HPV? . .

The debates as to what is a HPV in HP 10/1 were interesting, but they employed a sort of semantic logic, looking to the authority of dictionaries, or an attempt to establish new definitions for a set of words, that will not likely resolve important issues about HP transportation.

I see three main sets of issues. There is the ecological and sustained-economy interest in having more-practical transportation take place by HP devices on land and water. Bicycles, tricycles and hand carts meet the needs of billions of people throughout the world. Some of us are interested in seeing such vehicles, that save petroleum, reduce pollution, and provide good exercise, replace what we see as the over-use of automobiles in modern society. This area of interest involves both technology and politics.

Then there is the technical fascination with vehicles that do a given job better or make what was impossible in the past possible in the future. Perhaps this is the main focus of "a superb engineer and author" such as Rob Price. Others, such as Peter A. Sharp, who opposed the Price definition of an HPV, seem very much interested in the technical aspects of HPVs that may be used by both ordinary people, such as those Chinese who use bicycles, and superior ath-

letes who may go higher, faster, and longer with the help of new technology.

A third group seems most interested in the establishment of records that combine both athletic training and technology such as that required for HP flight or for the fastest way to cover a given course. In this group may be some of those who would like to see major bicycle races include an open class with aerodynamic and recumbent vehicles included.

It seems to me that one association and journal such as the IHPVA can accommodate these three areas of concentration, and many others.

David Dibble, 2806 Bellaire Place, Oakland, CA 94601-2010

## Response to Letter by Peter Sharp: "It's Time to Change the Rules", Human Power, Spring-Summer 1992

I am very proud to be a member of the IHPVA as I see it as a group that does indeed encourage innovation through a minimum of rules and regulations for the sponsored competitions. I have been involved with many competitions and organizations ranging from professional auto racing to high-fuel-economy events to regular UCI meets, and I feel very comfortable with the level and content of regulations that the IHPVA has in place.

It was in this context that I read Peter Sharp's letter in the last Human Power regarding the rules of the IHPVA. I felt it was necessary to respond to some of his comments and arguments since they tended toward the absurd.

He is correct that a vehicle fairing can act as a "powered aerodynamic device"; any device or shape that is basically an airfoil (or even a circle!) in plan view can act as a "sail". Before we can condemn fairings, though, we have to look at what is gained and lost by the use of a fairing. Through past experience in high-fuel-economy competitions with "Super Mileage Vehicles" (SMVs), I have done a great deal of work with the use of body aerodynamics for drag reduction at low speeds. SMV competitions are run at an average speed of 25 kmh where the effects of ambient winds are much more pronounced than in HPV events. Through several generations of design, a body was designed for one

vehicle that featured negative drag (net thrust) at a yaw angle of 12 degrees. At any wind speeds great enough to cause the yaw angle to increase beyond that point, the vehicle body acted as a very good sail!

The key point here is net thrust. At any point up to negative drag, or a Cd of 0.00 (in this one case at 12-degrees yaw), there is no net thrust or power from the wind; there is only a reduction in drag! In one specific competition where this vehicle was entered (and a world record for fuel economy at 5691 m.p.g. was set), the cross-wind effect reduced the apparent Cd of the vehicle from 0.15 to 0.02 as averaged over the total course length. While a benefit was gained from the ambient wind conditions, it was not a net benefit or gain over the total losses due to aerodynamic drag.

In HPV competitions, the speeds are typically much greater and as a result any ambient winds would have to be very high to give a net benefit or "sail" effect. At a speed of 100 kmh, a similarly designed HPV would need a cross-wind condition of 26 kmh to realize negative drag or net thrust; this wind speed is both against current IHPVA rules and tends towards being suicidal!

I believe that the optimization of body shape to use the wind to reduce drag is acceptable but the line must be drawn when you generate net thrust, at which point, in my mind, you become a land sailer. This was attempted with the next-generation SMV where "crab steering" was adopted on all three wheels to permit the vehicle to generate essentially its own yaw angles (I think that the sailing equivalent would be tacking into the wind). The vehicle had superb performance (on one test it went over 5 km on a circular track with no engine burns!) but it was ruled illegal for going "against the spirit of the competition" and rightly so!

We must learn to live with the wind as there is no way we can avoid it short of holding all events indoors with any ventilation turned off. The rules set a maximum wind speed for records (as do most other sporting events) that minimizes its effect. The basic vehicle dynamics of most HPVs prevent transgressions of the rules, with a crash being the penalty for trying.

The use of the HPV itself as an energy-storage device to a certain extent cannot be avoided. Until the basic laws

## Regulating HPVs: a side-bar from Rob Price

Several of my critics commented on government and racing-organization regulation of HPVs, citing the UCI bans on anything but diamond frames, and on streamlining. I think that the UCI may have taken a bum rap on that score, that the tinkerers, who were diligently making improvements to cycling as fast as materials and manufacturing technology would allow, were endangering the growth of the cycling industry at a time when it was competing with automobiles. Racing was and is the preferred method of popularizing transport, and the UCI tried to focus public attention on what, in those days as well as today, is a safe, easy-to-use and inexpensive standard for competition and daily transport. Compare these to the ordinaries they displaced. This was in the days of fixed-gear brakeless six-day races that proved speed and reliability over the competition, cars and airplanes struggling to cross the country amid seas of muddy-rutted paths and pastures.

Bicycles have improved greatly since then, in tire technology, derailleurs and brakes etc., within the UCI, before the IHPVA came along. The UCI didn't ban improvements, e.g. streamlining, they just didn't want to administer more classes of competition.

I think the same thing will happen in the IHPVA. We are already split into three factions that are slowly diverging. The big draw is land machines, with many classes of competition. Watercraft seem to be dividing into surface craft and submarines. And aircraft are now a mature technology, with helicopters soon to lift off.

HP aircraft do not come to the HPV championships and the watercraft competition requirements are difficult to reconcile with land-competition requirements. I see separate championships, run by separate groups at separate locations and dates. The IHPVA will continue to hold it all together with Human Power and the HPV News, but the effort required to stage championships involving so many classes entirely by volunteers dictates a winnowing to make it possible to stage any events.

Peter Sharp criticized the IHPVA for restricting racing rules and feared it would restrict human-power development. Anyone interested in an area not already addressed can stage events either within or outside the IHPVA. Even non-human energy assist gets publicized in our publications.

But perhaps the all-inclusive nature of IHPVA has worked against it. Once the UCI focused on the diamond-frame bike it became

the best engineered, most reliable, most prevalent form of transport in the world. The IHPVA's lack of focus may have prevented a superior replacement from being developed and perfected. Or perhaps the bicycle is nearly perfect for all its uses. Surely that was not brought about by a committee called the UCI?

On government restrictions, even the Consumer-Product Safety Commission hasn't banned bikes or sidewalk tri-cycles, statistically extremely hazardous machinery, not have they been able to legislate any more than reflectors, minimum-insertion markings of seat and handlebar stems, and curved ends on quick-release skewers. They have helped make better helmets readily available and have not forced spoke and chain guards on us. The rugged individualists in the IHPVA probably loathe regulation. We also loathe rapacious opportunism, and it is as rampant in the bicycle industry as in any other. If for once a branch of the government can provide real help, I for one will consider its offer.

*Rob Price, 7378 S. Zephyr Way, Littleton, CO 80123, USA. 303-973-6105*

*Letters, cont. from p. 5*

of physics can be re-negotiated, we must live with the fact that an HPV has mass and inertia and there is nothing that we can do about it. As far as I am aware any attempt to increase the inertia of an HPV to make it a better "energy accumulator" has been very counter-productive due to the decreased acceleration and increased rolling resistance that results.

I agree that an "energy accumulator" has its places (as already permitted by the existing rules) and I hope that Peter's design works well; I see that it would have some definite advantages, particularly in the "real world". However, I see any design of that type as a hybrid of human and stored power. Whether the power is stored in the form of pedal power transferred to a spring or a battery or in a tank of gasoline, it remains an added source of energy. If this is permitted, rules must be set (as Peter has recognized) as to what is acceptable in terms of storage. At this point, we are just generating more arbitrary regulations which are what Peter is rallying against in the first place and are the last things that any organization needs. As someone who is very interested in



*Peter Ross at a British HP Club meeting*

Peter first became interested in HPVs in the early eighties when successive fuel crises made him consider alternative ways of making the 38-mile round-trip from home to work. It was a photo of the Vector taking part in the Brighton Speed trials that made him realize that here was a bunch of people who knew something about low drag. Never having seen an HPV, Peter made a trike (called "The Breadboard") and entered a race in 1983. His next vehicle was the first Trice, with streamlined body, which he employed to commute to the office (with a little help from an electric motor).

By now a convert to HPVs in their own right, Peter realized that public acceptance would be slow unless these vehicles could be bought ready-to-use, and he started making and selling the Trice in 1986. At this time he was the only UK HPV maker (Speedy having ceased production). Market research showed demand for a bicycle, and the Ross Recumbent appeared in 1989 at the same time as a lighter version of the Trice. Lightweight streamlined production bodies followed.

A great believer that HPVs must be thoroughly practical, Peter sees the future of HPVs moving in two directions: a major manufacturer produces an HPV bicycle and sponsors races, thus forcing acceptance of an HPV class in international bicycle racing; and the production of enclosed recumbent tri-cycles, probably with two seats and good luggage space, with electric or I.C.-engine assistance on hills, to replace the family second car.

Now 63, Peter is not interested in being involved in the mass production of his designs, but he would like to continue to develop new ideas.

*Crystal Engineering, Copper Hill Works, Buller Hill, Redruth, Cornwall TR16-6SR UK, phone (011 44) (0)209 218 868*

Letters, continued from p. 6

hybrids, I think that is time to consider regulations to set up a "hybrid competition" of some kind, but it must be kept separate from the existing HPV sprints.

An HPV with an energy accumulator is definitely different from an HPV without one; as a result they should not compete against each other.

Whatever the field of human endeavour, some rules must be set to prevent chaos (we wouldn't want an Indy car running in an HPV mass-start event!) from setting in. I personally like the existing IHPVA regulations as I find them excellent in definition and scope even given their constraints. My vote is to keep the regulations as they currently stand.

Tim Leier 1146 #3 College Street  
Toronto, Ontario M6H 1B6, CANADA  
(Tim Leier has an article later in this issue illustrating some of his arguments. I regret not having the time earlier to send Tim's letter to Peter Sharp to give him a chance to respond here. There are interesting points still being made in this series of letters, and we welcome its continuation for another issue or two. You will also see a "sidebar" from Rob Price on a related topic. Dave Wilson)

## Human power in agriculture

Greetings from Hudson County Community College in NJ, where I teach engineering science and math. . . I read about the IHPVA and Human Power in the July/August 1992 issue of Professional Engineering. . . I have done some interesting developmental work for the utilization of bicycle power for operating small-scale farm equipment like a chicken plucker, a seed-cleaning and -grading machine, etc., published in the JI. of Agricultural Engineering Research, Agricultural Engineering and similar technical journals. . . The mechanism used to transfer human power through the bicycle does not affect the use of the same bicycle for its normal operation in transportation in any way. . . I would be willing to share more information about the mechanism with your association . . .

Biswa Nath Ghosh (prof. of engineering science & mathematics) 299 Sip Avenue, Jersey City, NJ 07306

(We have asked for an article for HP).

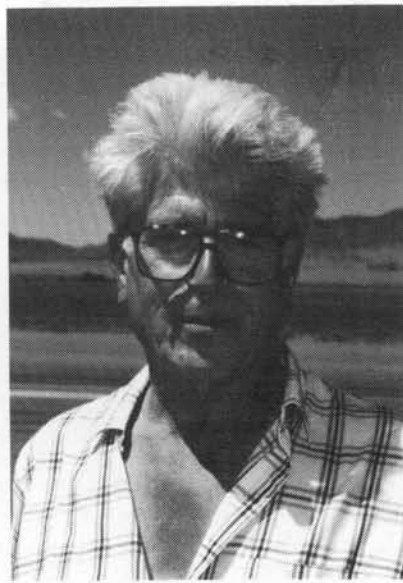

John Kingsbury at Yreka, CA, 1992

Photo by Ellen Wilson

John was typically reticent and modest when I asked how his interest in HPVs began. "I was challenged at a pub "round table" meeting in about 1982 to do better than a pedal car called the "Bacon Slicer". My son Miles began his interest in HPVs at about the same time. [See HP7/4/88/11 for Miles Kingsbury's piece on "The baking of the Bean"]. My company worked in teleprompters and I was doing various mechanical-engineering studies - they're all computerized now. I retired in 1987 and became secretary of the British Human Power Club. What would I like to accomplish next on HPVs? Good linear drive, and front suspension. John modestly didn't mention that the Kingcycle "Bean" holds the one-hour record at 46.96 mph - 20.99 m/s - for the full story, read his piece "The hour attempt" in HPV News 7/3/1990/pp 5-6 in addition to Miles' background piece quoted above.

- Dave Wilson

John Kingsbury, 22 Oakfield Road, Bourne End, Bucks SL8 5QR, UK

## Reviews

### The British Human-Power Club newsletters nos. 31 & 32

The newsletters are informal ("chatty") and mainly given to racing and development news among a group of enthusiasts that know each other well. Thus some comments are obscure to outsiders. There are also many gems of wisdom and HPV science to be gleaned. In the summer '92 issue I enjoyed particularly two articles by Hugh Roberts: "Steering and stability" and "Shimmy, or

the tea-trolley syndrome" because the advanced math of many papers on single-track-vehicle stability leave me behind and gasping. Hugh Roberts has down-to-earth common sense and some surprising results from experiments, some of his and some of others, including those of the universal Mike Burrows, the newsletter editor. I liked Roberts' quote of one Glegg: "Machines are superb mathematicians: they live and work by mathematics. It is up to us to understand their mathematics. . . ." I wrote to Hugh Roberts to ask permission to reproduce his articles. He is rewriting and updating them for us - look for them in an upcoming issue.

The Autumn 1992 issue no. 32 has a first report by John Kingsbury on the IHPSC in Yreka, and includes a photocopy of a friendly letter from Fast Freddy Markham after he missed saying goodbye. As an ex-Brit I'm always sensitive to Anglo-American attitudes, and those in this issue were all positive, or as positive as one can be about LA beach culture. There was also a good (as usual) letter from Doug Milliken paying compliments to the Roberts' article and a companion one by "Jake the rake Young", and giving some background to other studies of bicycle stability.

There are some great HPV cartoons, and a lot of casual photos (including Mike Burrows pedalling an "errand-boy's carrier bike" and, in priest's garb, pulling a confessional and, apparently, hearing a confession en route.

Dave Wilson

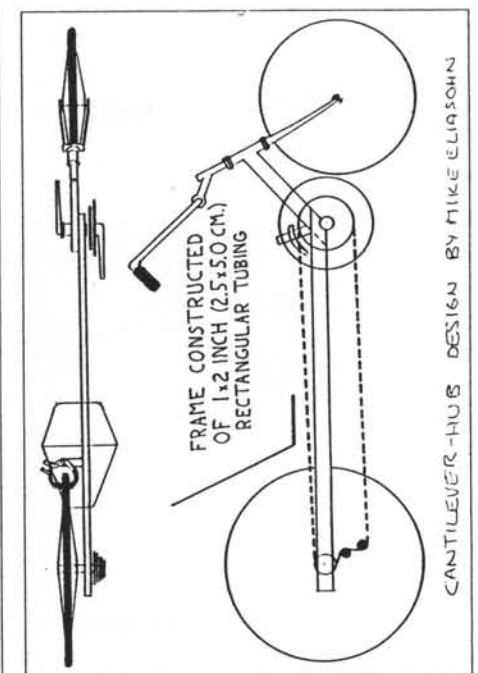

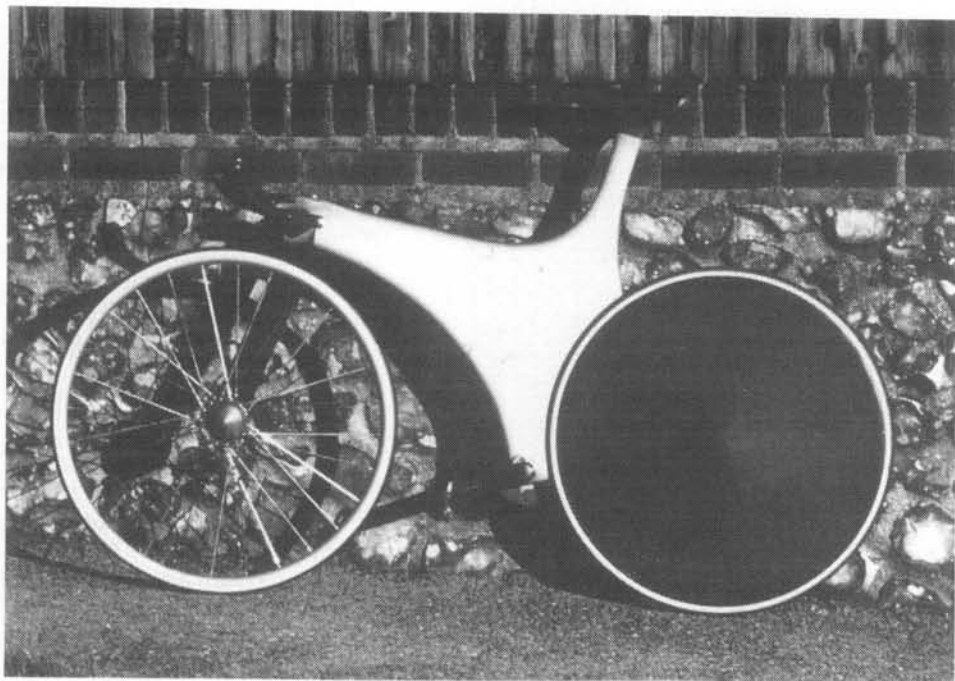

BURROW'S ENGINEERING  
 11 Basey Road  
 Rackheath Ind. Estate  
 Norwich, Norfolk. NR13 6PZ  
 Tel: Norwich (0603) 721357

photo courtesy of Open Road, York, U.K.

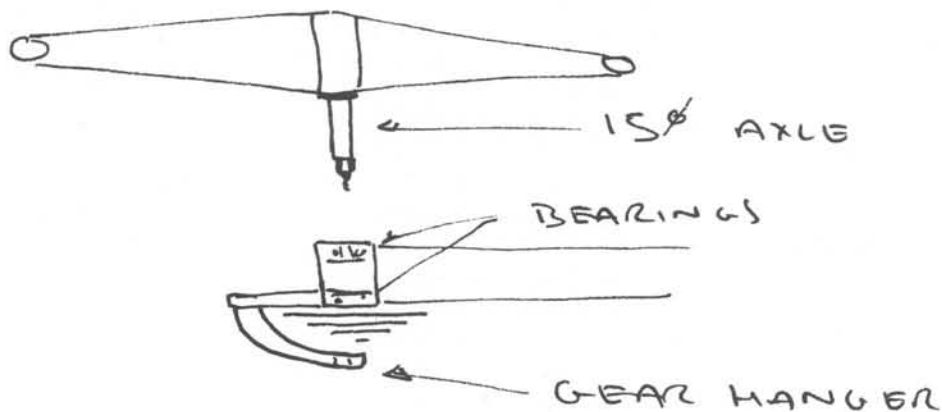

SKETCHES  
 FROM/BY  
 MIKE  
 BURROWS

TOP VIEW CURRENT MK IIIA

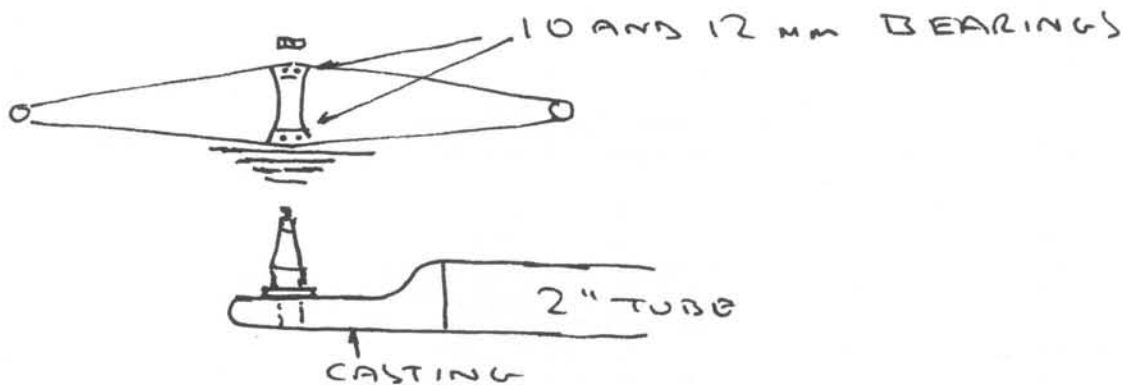

TOP VIEW ORIGINAL (MK II) HUB SYSTEM



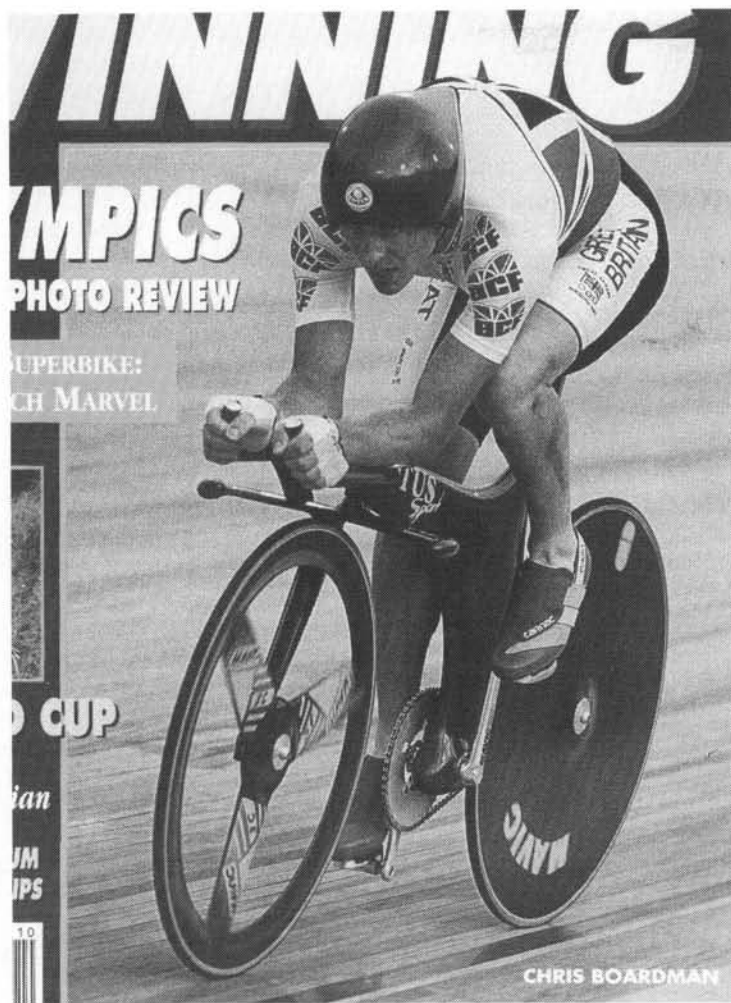

Chris Boardman on the Lotus Sport Illustration by courtesy of Winning

## CANTILEVER WHEEL HUBS

by Mike Burrows

Introduction by Michael Eliasohn

The bicycle that Briton Chris Boardman rode to a world record time in a qualifying round on his way to winning the 4,000-meter individual pursuit at the 1992 Olympics in Spain attracted lots of attention for understandable reasons.

The carbon-fiber monocoque frame that formed an airfoil was part of the reason. But making the bike even more aerodynamic was that both wheel hubs were supported on the right side only -- one less fork blade and rear-wheel stay sticking out in the airstream.

Boardman's bike was designed and built by Lotus Engineering, the engineering division of the British sports-car manufacturer. But the design was based on earlier carbon-fiber bikes with one-sided hubs built by Mike Burrows.

Burrows is well-known to long-time IHPVA members as the builder of the Windcheetah/Speedy recumbent tri-cycles. He has also built lots of other interesting HPVs, some with the rider in the recumbent position and some upright. Many of his designs use one-sided hubs, otherwise known as cantilever hubs.

As Burrows notes in his article, the idea isn't new: a bicycle built in 1889 used the concept. Jim Hickey of El Cajon, California, U.S.A., owns an upright bicycle, believed to have been built in the 1920s, that uses cantilever hubs front and rear. The builder of his (presumably) one-off bicycle is unknown.

There is, or was, a mountain bike manufactured in France, the Laiti, that

uses cantilever hubs with drum brakes front and rear. An American BMX bike, the Kastan, uses, or used, a single-blade fork. (I don't know if either bike is still in production.)

Other one-off cantilever-hub bikes have appeared from time-to-time. No doubt at least some of their designer/builders thought they were the first to develop such a design.

Cantilever hubs have several potential advantages, in addition to improving the aerodynamics of cycles such as Boardman's designed for high performance.

1) Simplified frame design. The frame of the Speedy/Windcheetahs forms a simple T. A recumbent bicycle frame could consist of one or two tubes -- no need to build two separate rear stays. A simple proposed design by the writer of this introduction accompanies this article.

2) Lighter weight. Eliminating a fork blade and rear stay presumably will result in a lighter frame.

3) Storage and transportation. At least some designs with cantilever rear hubs allow the wheel to be removed without disturbing the derailleur or chain -- those components being mounted on the right side of the single stay, while the wheel mounts on the left side. Thus both wheels can be easily removed, resulting in a compact package for storing or transporting the cycle by car. This would be especially advantageous for a long-wheelbase recumbent.

Unfortunately because of the machine work involved in making the axles and hubs, cantilever hubs aren't a project for amateurs -- unless they have metal-working lathes in their garages. Perhaps a HPV builder/machinist might like to produce some cantilever hubs for amateur HPV builders who aren't machinists.

At my request, Mike Burrows kindly wrote the following for HPVs interested in cantilever hubs.

### MAKING IT EASY

by Mike Burrows

My first cantilever wheels were on my first-ever HPV, but as they were the two rear wheels, nobody noticed anything odd, not even me, because, of course, all trikes -- and autos -- hang their wheels off the side.

The first one to be "funny" was on the single rear wheel of the Mark II Speedy. The Mark I had used a

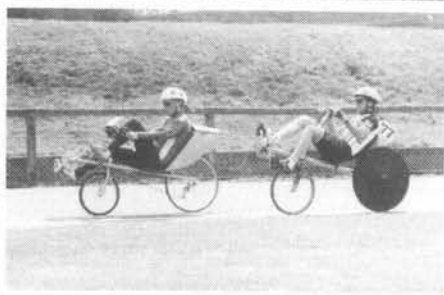

Jan Sheen on original SWB (following Pat Kinch on Kingcycle, 1991 Southampton)

conventional rear triangle fabricated from welded alloy steel. This I was not happy with, though, as it was a lot of work and was taking the loads to a non-existent "top tube." This contrasted with the front of the chassis, which was a very neat and strong length of alloy-steel tube 2-inch (50-mm) diameter, 1/8th-inch (3.2-mm) wall.

Cutting this off and fixing in the rear end was never going to be easy or nice, whatever I did, so I didn't. I stuck the wheel on the LEFT side of the tube and put the chainset on the LEFT-hand side.

I spent a long time sorting out the chain line and that was it. It worked. The rear wheel was off center by about 2-1/4 inches (57 mm), but then the front ones were 12 inches (305 mm) off center. Two were built and then developed into the Mark III with more frame pieces being castings and the 17x1-1/4" (432-mm) Moulton wheels in front, a 24-inch wheel in the rear.

Being now "production" machines gave me a problem as I was making the left-hand front changers by hand (really dumb). So inspired by, I think, a Honda moped, I changed over to the current live-axle system. This is actually slightly heavier, but gives a very good chain line and uses standard derailleurs.

By this time (1983) my HPV design was starting to spill over into my Union Cycliste Internationale bike designing. The first (upright) monocoque design was registered in 1982, but it was only when I visited the Coventry Transport Museum and saw the Surrey Machinist's Invincible of 1889, which had a



The tourer "Vienna"

monoblade fork and single rear stay that I realized the potential for two-wheelers.

At first I made a monoblade from solid alloy for only the front of the monocoque, but when the RTTC changed the rules to allow disk wheels in time trials, I realized that the rear end would not only be a lot easier to make, requiring only a simple two-piece mold as the wheel, but the "slot" would be eliminated.

This design also suited carbon fiber, as a large bearing housing could be moulded in, rather than having to use the traditional dropouts. The only real negative was the need to offset the rear wheel 16 mm (0.6 inch) from the center line.

To check the effects of this on a bicycle, I built a short-wheelbase recumbent with a Speedy-type rear end (2-inch/51-mm wheel offset) and a monoblade front fork. This worked fine once the head angle had been sorted out and so the final upright monocoque was built. I rode it in several local events and did some very good times for an



Original monocoque with first alloy monoblade

"old man." Eventually it was seen by Lotus and you all know what happened then.

For various reasons I ended up building a series of cantilever cycles for more down-to-earth uses. The first was the Amsterdam, a 20-inch (510-mm) wheel shopping bike using drum brakes front and rear on a TIG-welded steel frame. This makes for a very practical low-maintenance utility cycle.

Next was a touring bike with 700C wheels using alloy tubing and castings, plus carbon fiber, and using a Moulton rubber squash ball for rear suspension and a Flexstem (designed for mountain bikes) at the front. This was followed by an off-road version, again with drums, etc., and finally a long-wheelbase recumbent.

Wheel offsets on these are anything up to 51 mm (2 inches) on the Amsterdam to 1-1/4 inches (32 mm) on the tourer. Although you notice "something" initially, you soon forget it and

it's just another bicycle. Cantilever hubs are neither better or worse than any other system. They have advantages and disadvantages. You just have to use them in the right places.

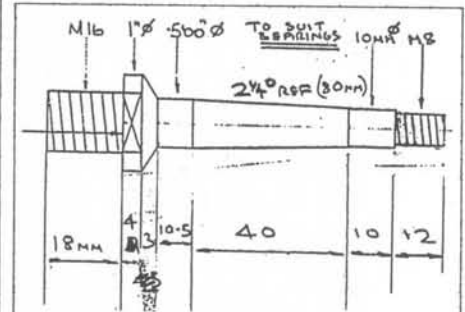

Front stub axle in EN 16T

### Some design aspects of cantilever hubs

Bicycle axles are not thick enough. I adopted tricycle standards, which specify 1/2-inch diameter at the root (12 mm is okay) and taper to 10 mm at the outer end, with M8 or M6 thread and M16 to mount the axle. [This designation is the thread diameter in mm - ed] Rear axles are 15-mm diameter to allow for the 1/2-inch AF HEX.

Always try to use good steel. I use 605M36 for fronts and 080M40 carbon for the 15-mm rears.

Always use large-cross-section monolithic structures off which to hang your axles. I use 1-1/2 inch (38-mm) outside-diameter, 1/8th-inch wall 6063 alloy tubing for the front monostay fork on bikes.

All my bikes seem more prone to shimmy than usual. This does not appear to be connected with a lack of stiffness, so could it be the offset mass? It's no problem if you hold onto the handlebars, though.

The system can be made very light. The rear hub/axle assembly on the current Mark VII Speedy runs in 20-mm races, is made from one piece of high-strength alloy STEEL and weighs 100 grams including the races.

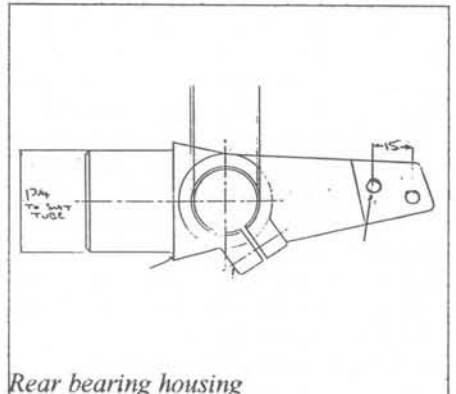

Rear bearing housing

# Triton vs. Deep Purple

by Cory R. Brandt and  
Doug R. Ackerman

The *Triton* and *Deep Purple* (figure 1 and 2 respectively) are entries into the "1993 3rd International Human-Powered-Submarine Competition".

The *Triton* (named after a mythical half-man half-fish) is being designed and built in the Seattle area by an independent team. *Deep Purple* is being designed and built by students in the University of Washington's Mechanical Engineering Department (its name was selected in part because the University's school colors are purple and gold).

The information that follows will compare the two designs and detail why certain design choices were made. However, in the interest of competition, some detailed information is left out. In fact, many design details of the *Triton* are not known by the *Deep Purple* team, and vice versa.

## Race basics and history

The competition is organized by the H.A. Perry Foundation and Florida Atlantic University's Department of Ocean Engineering. It is open to colleges, corporations, small businesses, and individuals. There will be entries from Britain, Germany, Canada, the United States, and possibly even Russia at this year's competition.

The present world records are 4.71 knots (2.45 m/s) (unofficial) for a propeller-driven vehicle and 2.9 knots (1.5 m/s) for a non-propeller vehicle (official). The records are for two-person vehicles with one person providing the power. The speed is an average over 100 meters, with the vehicle starting from a dead stop.

The races have grown from 19 entries in 1989 to more than 50 entries for the 1993 competition. This year's competition will be in Ft. Lauderdale, Florida from the 16th through the 27th of June, 1993.

The vehicles are seeded by their speed on a 100-meter straight course. They then race head-to-head, based on seeding, twice around a 400-meter oval for an 800-meter overall course length. This year's course will be run in the ocean at a depth of 6 - 7.5 m. The races

are run in a single-elimination tournament format with the victor continuing to the next round.

Each vehicle is required to have two occupants, but only one occupant may provide the power input that contributes to the forward momentum of the vehicle (the other is the navigator). The vehicles are fully flooded, and both occupants breathe from SCUBA systems.

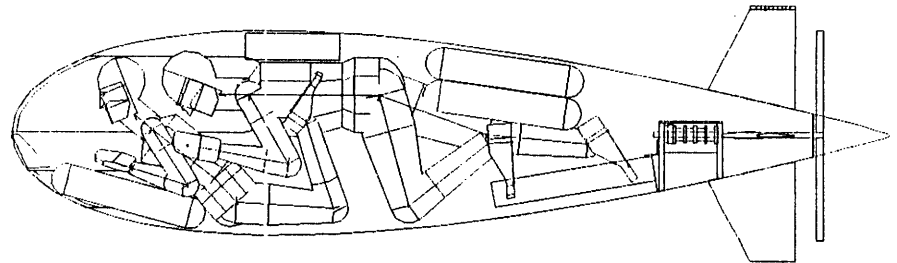

Figure 1: The Triton. The Triton is 3.5m long, 584mm wide, and 813mm tall.

## Hull Design and Occupant Positioning

To design a competitive human-powered submersible one must work through a series of iterative loops. The main loop is shown in figure 3. Both the *Triton* and *Deep Purple* teams started the iterative process by striving to minimize the displaced volume. The teams used three-dimensional computer graphics software to loft different low-drag hull shapes over computer renderings of their crew. The problem arose in deciding how to weigh the importance of a person's power output relative to the hull size and drag.

The *Triton* team stated early that, barring major volume reductions, they would limit the positioning of their propulsor to the prone or fully recumbent positions. These positions were chosen because they were determined (in an unpublished naval study) to be the two positions that provide the maximum power output with minimal air consumption.

Minimum volume and low drag, rather than stoker position, were given as the starting point for the design of the *Deep Purple* hull. The race rules require the submarines to carry sufficient air for 20 minutes of racing plus warm-up and cool-down periods. Competitive participants will probably need to complete the course in less than ten minutes so air-consumption rate due to stoker position was not given a high priority by the *Deep Purple* team.

Optimum vehicle shapes for several combinations of stoker and pilot positions, and linear and rotary drive sys-

tems, were developed and evaluated. Several asymmetric shapes were considered; however, when manufacturing time and cost were added as a design constraint, further work on these shapes was abandoned. The *Deep Purple* layout has the stoker in a semi-recumbent position with his back overlapping the legs of the pilot (the pilot is in the prone position). This configuration allowed for the smallest cross-section and the least displaced volume compared to other layouts.

Both teams made a calculated trade-off. The resulting vehicles have nearly identical wetted-surface area and displaced volume. They both displace less than 0.85 cu.m.

## Frame and skin

The *Triton* team chose pre-impregnated graphite epoxy as the material for the hull. This results in a sturdy vehicle with no internal framework and a wall thickness of less than 1.5 mm. The result is an extremely strong and lightweight hull. The thin walls also

help minimize the frontal and surface area of the craft.

The *Deep Purple* hull will be made from a wet lay-up of fiberglass and epoxy resin reinforced in high-stress areas with Nomex honeycomb and carbon fiber. The hull must be thicker to achieve the same structural strength and rigidity, but the cost of construction will be less than using a more advanced composite for the entire hull.

the vehicles use rotary drive systems (i.e. a bicycle crank). The *Triton* and *Deep Purple* will be using linear drive systems.

There are two main types of linear drives: those that use a single pivot point, and the ones that have the pedals run on slides. The single-pivot-point design is simpler because the bearings are located in one central location (the pivot point). On this type of system the

cadence results in a 50% reduction in the power expended shifting water inside the vehicle. Also the biggest drawback of linear drive systems for land vehicles is their weight. In wet submersibles weight is not an issue because the volume the vehicle displaces establishes the mass it must accelerate.

A well-designed linear system should have a varying gear ratio through the stroke (similar to an elliptical sprocket on a rotary system). It will also allow the propulsor to vary his stroke length at will, and permit power input on the up and down strokes.

Further details of both drive systems and propeller designs are still competition-sensitive and are not included.

### Vehicle control

The next issue is how to control the vehicles. There are almost an infinite number of choices. When induced drag created by the fins is considered critical the number of choices is drastically reduced. Placing the fins on the front creates some instability. This instability can easily be overcome by manual adjustments; however, each adjustment is a drag increment. Although both teams considered locating the fins on the front of the vehicle, they decided that the drag penalty was too high.

The *Triton* team is placing the control surfaces in front of the propeller. This is less complicated mechanically and creates less drag than having the fins behind the propeller. However, placing the fins behind the propeller will increase the induced efficiency of the propeller (since less energy is wasted swirling the water) so that it also results in an increase in vehicle control at low speeds.

The *Deep Purple* team decided to locate the control surfaces behind the propeller. This arrangement allows for smaller control surfaces, producing less drag, for two reasons: 1) the fin surface area required for stability is inversely proportional to the distance from the center of gravity, and 2) the fins experience a higher water velocity. Also, effective directional control is available at lower speeds and the flow into the propeller is not disturbed. The price for all these hydrodynamic benefits are the mechanical difficulties of supporting the control surfaces behind the propeller.

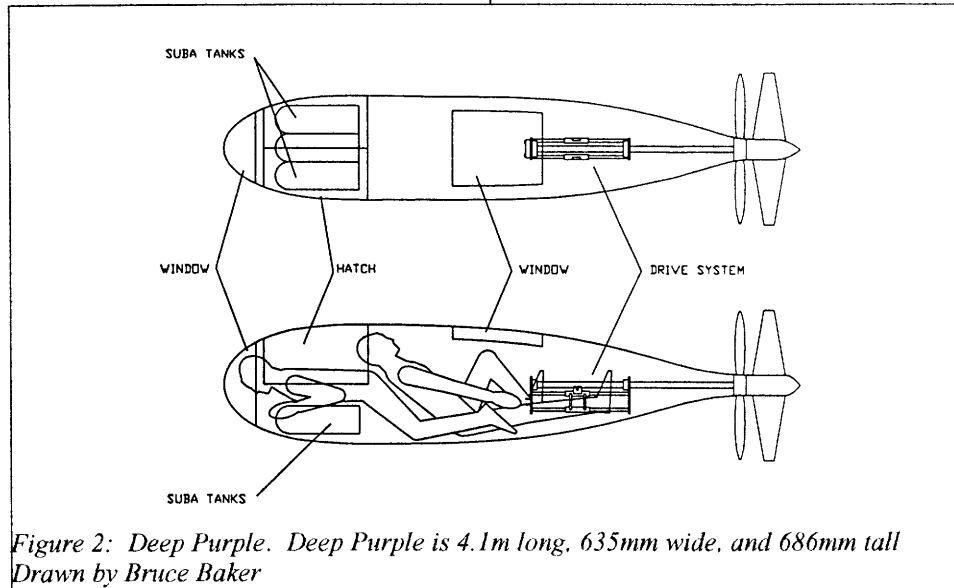

Figure 2: *Deep Purple*. *Deep Purple* is 4.1m long, 635mm wide, and 686mm tall  
Drawn by Bruce Baker

### Power conversion

The next big design decision was how to transfer the power from the propulsor to the water. The entries are not limited to propellers, but it is difficult to match a propeller's efficiency; hence, both the *Triton* and *Deep Purple* are using propellers. Both teams are using two-bladed propellers operating near 200 RPM and mounted on the aft end of the vehicle.

When choosing a propeller one must establish the type (counter-rotating, ducted, shrouded, etc.) and whether to put it on the front or back of the vehicle or somewhere in-between. Other decisions must be made as to the propeller's size and RPM. Typically ducting or using counter-rotating propellers can increase propeller efficiency; however, the benefits diminish in low-horsepower vehicles when the drag and mechanical complications are considered. Also, since we can use large-diameter propellers the tip losses are already low; hence the payoffs of ducting or using counter-rotating propellers are reduced.

Another part of the power conversion is the drive system. The majority of

feet actually sweep out an arc. The slider systems are typically more complicated mechanically, but take up less room since they don't require a large swept-out area for the pivot arm and propulsor's feet.

Due to the importance of space both the *Triton* and *Deep Purple* will be using the slider system. However linear drive systems have many disadvantages when compared with rotary systems. They are more complicated, more costly, heavier, replacement parts are harder to find, the optimum stroke length is longer, and there is a momentum loss since the propulsor's legs come to a complete stop between strokes. Another disadvantage of a linear drive system is that cyclists are less accustomed to operating the system, so training time is involved. However training time should be incorporated anyway since few cyclists are accustomed to competing while underwater.

So why even consider a linear drive system? When operating a linear system the propulsor's legs sweep out about 30% less area than on a comparable rotary system. Underwater this reduction combined with the lower optimum

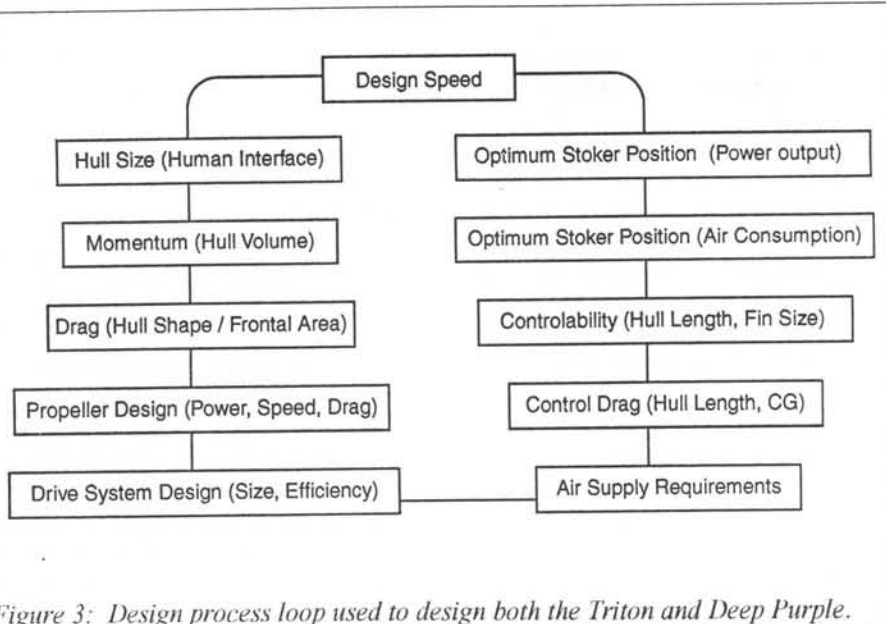

Figure 3: Design process loop used to design both the Triton and Deep Purple.

### Other systems

The next question is how to supply ample air to the occupants. All of the entries will be using SCUBA systems. As air is used in a SCUBA tank it becomes lighter. As a result, the vehicles tend to rise as air is used. To counteract this force most teams use ballast tanks releasing air as they operate. The majority of teams also use trim-adjustment systems. Trim adjustment is critical if the vehicle doesn't have the tank's center of buoyancy located directly above the vehicle's center of gravity. Due to spatial constraints and ease of adjustment, both the Triton and Deep Purple will be using a single ballast tank combined with moveable weights for trim adjustment. However, many teams will have the weight fixed and adjust the trim using two ballast tanks.

Both teams will be using commercially available 20 MPa SCUBA systems. The Triton will have a specially fabricated high-pressure link between six 0.85-cu-m tanks. Deep Purple will be using three 1.8-cu-m tanks connected to a low-pressure distribution system.

### Conclusion

In closing it must be said that the information in this article represents the opinions and knowledge of two submarine designers and their teams. We don't claim to know everything and are more than happy to listen to questions and comments.

These vehicles will be tried in the underwater competition. They will add to the growing knowledge base of

human-powered and underwater vehicle design.

Cory Brandt, 115 N 82nd Street  
Seattle, WA 98103

Doug Ackerman, 8026 12th NW  
Seattle, WA 98117

Doug Ackerman is co-heading the University of Washington's Deep Purple team. He has a BSME from the University of Washington and worked on the SeaDAWG which took fourth place overall in the 1991 competition. He presently works for the Boeing Company and is pursuing a MS in mechanical engineering.

Cory Brandt founded and is leading the Triton group. He is a University of Washington BSME graduate, and is presently working for the Boeing Company on the F-22 Advanced Tactical Fighter Program. Cory also worked on the 1991 SeaDAWG.

## REVIEWS hpv nieuws

The Netherlands counterpart to our HPV News is also published six times per year, usually beautifully produced with large glossy photographs and line drawings. Because it is the only publication of the NVHPV it combines news and some technical articles. The degree of activity and of innovation is always impressive. We had the pleasure of having Bram Moens in the 1992 IHPSC riding his "M5" as an example, briefly

noted in our last issue. The predominant configuration is, like the M5, a SWB with a high crank position giving a low frontal area whether faired or unfaired. One of the NVHPV leaders, Bernd Zwikker, gave the arguments for this position in his paper "Riding position and speed on unfaired recumbents" in HP8/2/90/p.1. An example of this configuration with rear suspension is the "Challenge", produced by Advanced Cycle Engineering (Diepenbroekstraat 15, 7031BT Wehl). The drawing below is taken from an advertisement in the October, 1992, issue. Elsewhere in that

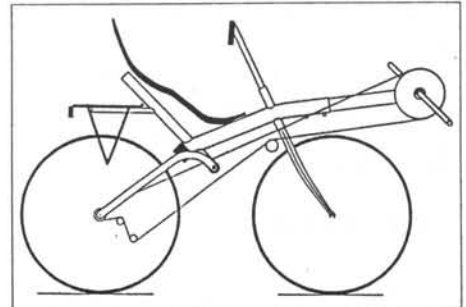

issue is a sketch of the new drive of the FWD Flevobike, reported in HP 9/2/91/p.15. My Flemish is nonexistent, but who cannot translate "Een derailleur-versnellingsysteem" that is enclosed and is applied to a composite wheel on a monoblade fork, apparently with springing? If Johan Vrielink is actually developing this, it would be the most innovative drive available. I have long

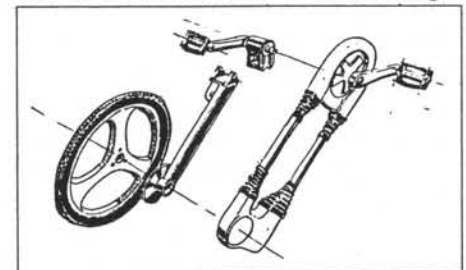

wanted an enclosed derailleur system.

The cover photo of the undated vol.8/5 issue, presumably Nov./Dec. '92, is of a SWB recumbent with what seems to be linear rowing-type foot motion and coupled rocking handlebar (see p. 18, lower right). I couldn't find any description of this interesting machine inside the issue, but will ask for more information. Similar drives have been used many times in the past but not, so far as I know, on SWB recumbents.

Dave Wilson

(The listed address for technical information is HPV-centrum Nederland, De Morinel 55, 8251 HT DRONTEN)

**SHORT-VS. LONG-  
WHEELBASE SEMI-SUPINE  
RECUMBENT BICYCLES**  
by Charles Brown and Jon  
Stinson

**Charles Brown**

After years of building and riding long-wheelbase recumbents, I made several attempts to build a short-wheelbase bike I would enjoy riding as much as my favorite long-wheelbase bike. I've recently given up the attempt and want to share what was learned with other HPVers. My friend Jon Stinson, one of Michigan's most knowledgeable HPV builders, has also built both types and he prefers the short wheelbase, so I asked him to add some commentary.

**Short wheelbase**

Let's imagine you are designing a semi-supine bicycle. Suppose you want the bottom bracket a little higher than the seat to reduce the air drag, and you raise the rider up enough to see and be seen in traffic. Aha! An area opens up under the knees where you can stick a little front wheel. The resulting bicycle is light, compact, and maneuverable. The main drawback is the ride, which, in the worst designs, is downright punishing. The short wheelbase and relatively high rider position aren't helping, and the main problem is too much weight on too small a front wheel. If you intend to build anything more than a toy, the front wheel must be positioned as far forward as possible.

Some years ago, David Gordon Wilson thought of placing the front wheel far enough forward that the rider's heels pass on each side of it. This requires that you move your foot out of the way on tight, low-speed turns, which you quickly get used to, and improves the balance of the vehicle so much that we heartily recommend it.

Even with this done, if you use narrow, high-pressure tires, the ride will still be quite rough. Jon Stinson uses a wide low-pressure tire on the front to soak up vibrations. You might think this would raise the rolling resistance unduly, but anyone who has raced against Jon can attest that this doesn't slow him down much. Charles has tried shrinking

the diameter of the back wheel to something approximating its proportional load. This significantly improved the bike's competence on corners, but with narrow, high-pressure tires, the ride still was not as smooth as desired. One interesting discovery on bikes with two identical wheels was that the ride was best with only about 40-45% of the weight on the front wheel. Motorcycles and automobiles usually steer best with about 49-52% of the weight on the front wheel(s).

**Long and mid wheelbase**

Long-wheelbase bikes excel where short-wheelbase (SWB) bikes have a problem: in ride, at the cost of greater size and weight. Some designers compromise between the two types of bicycles by jacking the bottom bracket way up over the front wheel. It is harder to get started uphill with your pedals high above the ground.

**Some advantages of the short-over the long-wheelbase bike**

- ✓ More compact, about 3/4 the length, which makes a difference. It fits in shipping containers, in vehicles and on car racks much more easily.
- ✓ Lighter, in Charles' experience, about 10% lighter when made of the same materials. Most of the weight savings is in the steering system, some in the frame.
- ✓ If you prefer having the handlebars in front of the chest, a simple direct steering system provides a desirable high steering angle.
- ✓ Easier to fit a full or other frame-mounted fairing.
- ✓ More maneuverable in really tight areas.
- ✓ Brakes and handlebar-mounted shift levers work better because of shorter cable runs.

**Some advantages of long-wheelbase bicycles:**

- ✓ Really smooth ride for a bicycle.

- ✓ Steering is easier to control on bumpy roads; whole bike has a more solid feeling, especially on rough surfaces.
- ✓ Steering is not as quick and twitchy, although, of course, some people like quick steering.
- ✓ Pedals can be close to the ground if desired.
- ✓ Easier to fit a partial, handlebar-mounted fairing.

I commute by bicycle, so mine must be able to make it through snow and gravel roads. On moderately rough or worse roads, the long-wheelbase bike is definitely better, so this is my own preference. I also recommend it for tourists.

Charles Brown, 534 N. Main #1  
ANN ARBOR, MI 48104, USA

\* \* \* \* \*

**Jon Stinson**

As far as I am concerned, trying to decide which is best, a long- or short-wheelbase recumbent, is not really the issue. The issue is, what's best for you, the end user. As Charles has pointed out, there are advantages and disadvantages to both the long and short versions, and, of course, there is a third version called the "Highboy", that should also be considered. I have personally built variations of all three and liked them all. However, I ended up with the short-wheelbase, simply because it was best for me.

My first motivation for building a recumbent was that it was different from the bikes that everyone else was riding, much like riding a "highwheeler" or a "cruiser". Second, once I found the recumbent fun to ride and at least as fast as a standard bike, the move was on to go faster. Herein lies the real reasons for the short wheelbase. My long-wheelbase, with 700c tires front and rear, turned out to be fast. Naturally, the rolling resistance was low due to the high-quality wheels and tires, and the long, flexible frame provided a great ride as far as comfort was concerned. The next logical step was to move the crank higher to reduce frontal area and enclose this whole contraption in some sort of body that would improve aerodynamics and also provide cold-weather

protection. This emerging vehicle would have to be practical since it would be mainly ridden on the road along with cars, trucks and all those types of hazards. There would be no one to push me off and catch me at the end of a ride. What we are talking about here is a practical vehicle. So how does all this get us to a short wheelbase? It's easy! Keep reading.

One, handlebars had to go inside the body to keep the frontal area down and to keep the hands and arms out of the wind. Also, handlebars in front of the rider is the most natural transition from a standard bike and allows the fairing to be only as wide as the rider's shoulders. Two, the 700c front wheel dictated a large rounded front-body section with a large opening in the bottom for the front wheel to stick through - bad for aero and crosswind stability. Three, I found it almost impossible to achieve balance starting out with the long-wheelbase tight-body configuration. The short-wheelbase with a small front wheel fixed both of these problems.

These motivations thus led me to the short-wheelbase direct-steering configuration that I now have. Once these basic design considerations were set, it's easy to justify the layout with adjectives describing its benefits. Again, the bike works for me and does what I designed it to do.

One other item that I would like to comment on is impact harshness. Charles is saying that the long-wheelbase configuration provides a softer ride. That may be true, but it is all tied into how much of the bump the tire/wheel combination absorbs and how much of that impact is transferred through the bike's frame to the rider. This is related to frame flex here, I think. With proper frame design, assuming the same-size wheels and tires, I contend that the two can be made to ride comparably.

Jonathan D. Stinson, 1201 Carol,  
PLYMOUTH, MI 48170, USA

*(Charles Brown is an independent developer; Jon Stinson is an engineer in the automotive industry with, I believe, Ford - ed)*

## Rolling-resistance test of small wheels

by Charles Brown

My interest in the rolling drag of small bicycle wheels was piqued when some calculations suggested that smaller wheels would be better for a land-speed-record vehicle, like Kingsbury's "Bean", and the new "Gold Rush Le Tour". Most recumbents have small front wheels, so this test is useful for practical vehicles as well.

The test was quite simple. I built a small ramp, and coasted the test bike across a concrete floor. I had the use of a large building to eliminate the effect of winds, but I imagine you could do it outside. I went both ways to reduce any effects from the floor not being perfectly level. My bike had almost all of its weight on the test wheel, and I took care to keep the weight distribution constant for all wheels tested. The effect of the non-tested wheel was then removed mathematically. Coasting speeds were kept low, under 3 mph (1.3 m/s) (walking speed), so that air drag would be negligible. I kept my path as straight as possible to minimize tire scrubbing.

You may be curious about the rolling drag of some tire not listed in the table on the next page. For example, the August-October '91 issue of "The Recumbent Cyclist" mentions a 60 psi 16" x 1-3/8" tire made by Michelin. Regrettably, I was not able to get one for testing. However, this test is easy to do: you can check things yourself without too much trouble.

A problem with this test method is that it does not directly give a coefficient of rolling resistance (Crr). To get a standard of reference, I coasted four different 27" x 1-1/8" Japanese tires through the course and got almost identical results for each, so I gave the average of these tires a value of 1.00, and used this relative rolling resistance as my basis. For example, a drag rating of 1.50 would mean 50% more rolling resistance than the 27" tire. For Chester Kyle's published testing, my baseline tires probably had Crr's of about 0.003 to 0.0035, so multiplying this by the rolling-drag rating would give a good idea of the Crr.

As expected, smaller wheel diameters, lower inflation pressures, higher tread weight, and knobby tires on paved roads all increase rolling resistance. What surprised me was that wider tires did not have noticeably higher drag, at least in this rather imprecise test. Curiously, the narrow, knobby Silver Star tire had slightly higher rolling resistance at the test pressure than at lower pressures.

The 16" and 18" Panaracer wheelchair tires were fast and amazingly lightweight. I've seen them used on racing HPVs, but they're very fragile. The Moulton and 20" IRC tires were sturdier, and still had low rolling drag, good for both everyday use and for racing. The IRC is a thin performance tire which Cyclo-Pedia sells (in '91) for only \$12.50. I've had one on the front of my Tour-Easy-like bike for about a thousand miles now. It seems to get about an average number of flats. The Moulton tire is expensive, but very tough - I've gotten about 5000 km on one. If you want a cushier ride or a wider tire, the HUDYN and ACS 20-inch tires are good choices. I really wish there were a high-quality 16" tire around for short-wheelbase bikes, such as a 16" x 1-3/8" Moulton, so that more commonly available parts would fit.

I would like to thank people who lent me tires and wheels for this test.

Cyclo-Pedia lent me most of the 16" and 20" wheels, including the IRC, RL Edge ACS. C-P also sells the Moulton and carries a selection of oddball HPV parts; its address is: P.O. Box 884, Adrian, MI 49221-0884, (517) 263-5803.

George Lindemann of K & M Designs was so trusting he lent me \$500 worth of the wheelchair wheels he sells. He can also do custom tube bending. His address is: 10030 Whitewood Road, Pinkney, MI 48169, (313) 878-0777.

Tom McGriff of HUDYN Vehicles gave me one of his 20" HPV tires. His address is: P.O. Box 22444, Indianapolis, IN 46222, (317) 241-6246

Charles Brown, 534 N. Main, #1  
ANN ARBOR, MI 48104

## MEASUREMENTS OF ROLLING RESISTANCE OF TIRES OF 20-INCHES (510-mm) DIAMETER AND BELOW

RIM BEAD SEAT DIA. mm.	NOMINAL SIZE	DESCRIPTION	BICYCLE TREAD	TIRES OUTSIDE DIA., in.	ALL WIDTH mm.	wired-on. WEIGHT, gms.	Inflation pressure, psi.	Rolling resistance compared to 27 inch tire
630	27X1-1/8	Typical Japanese tires, averaged	road	26.9	26		110	1
451	20x1-3/8	Saf-tee	small knobs	20.5	34	570	50-55	2
451	20x1-3/8	Carlisle Aggressor R/A	knobby	20.6	35	420	65 max	2.45
451	20x1-1/4	Hudyn HPV	slick	20.5	32	350	90	1.64
451	20x1-1/8	Mitsuboshi Silver Star Comp 111	knobby	20	27	280	75	1.91
451	20x1-1/8	IRC Road Lite EX	road	19.9	27	200	100	1.28
406	20x1.75	Kenda (K-Mart)	road	19.5	43	590	45 max	2.03
406	20x1.75	Tai Yung/Leo Freesyler	small knobs	19.5	42	440	40-50	1.95
406	20x1.75	RL Edge ACS	slight knobs	19.6	43	390	100	1.64
369	17x1-1/4	Moulton/Wolber (worn)	road	17.1	31	200	tested at 110	1.51
349	16x1-3/8	Golden Boy	road	16.6	34	340	50	2.9
340	400 A balloon	Hutchinson	road	16.6	39	330	55	2.16
305	16x1.75	HWA Fong	road	15.4	38	400	50	2.59
305	16x1.75	Tractor-grip	road	15.6	43	420	40	2.59

WHEELCHAIR TIRES-- all are tubulars, lighter and more fragile than the bicycle wheels above. Tubular tires can be pumped up to very high inflation pressures to reduce rolling resistance. 'Invacare' provides a wheel with a 267 mm rim diameter,\* Outside rim diameter is given.

381	18 inch	Panaracer rapide	thin road	16.3	18	125	110	1.64
330	16 nch	Vittoria Juniores	road	14.8	24	---	110	2.39
330	16 inch	Panaracer rapide (estimate)	thin road	14.2	18	120	110	1.94
235	12 inch (10 in.)	Panaracer rapide	thin road	10.2	18	115	110	2.8



APPROVED HP DESIGN ?

Cartoon kindly donated by Ron Sol



Typical SWB machine at the Wolverhampton HPV races, '91



# AERODYNAMIC GAINS FROM CROSS-WIND CONDITIONS

by Tim Leier

Human-powered vehicles (HPVs) gain their speed advantages over conventional bicycles by virtue of their reduced frontal area and reduced drag coefficients ( $C_d$ ).

The IHPVA has encouraged HPV design by sponsoring a number of contests and competitions with top speed as the main objective. Most competitors optimize their vehicles to have the best aerodynamics (i.e. lowest  $C_d$  or drag) under calm or tailwind conditions. Under IHPVA rules, there can be an ambient wind of up to 6 kmh or 1.67 m/s before any record attempt is invalidated as "wind-assisted". In the past, competitors have attempted to make record attempts with essentially no wind or with a wind at their backs for supposed maximum assist.

This article will document that with proper HPV and fairing design a greater benefit can be realized with the ambient wind being at 90° to the vehicle rather than parallel to the direction of travel.

Most fairing designs that are airfoil in shape in the plan view will act as a "sail" in appropriate wind conditions. In most cases, though, no benefit is felt at safe or IHPVA-legal wind speeds. Through optimized fairing design, it is possible to build a low-drag high-lift airfoil fairing that will display decreased  $C_d$  values in crosswind conditions. Anytime a vehicle is moving in a wind condition, the forward velocity of the vehicle and the wind velocity combine to form a resultant vector at a yaw angle of  $\beta$  (figure 1). The length and angle of the resultant vector will vary according to vehicle and wind speed and direction with a maximum  $\beta$  when the wind is blowing at 90 to the HPV path.

Most current road vehicles display an increased drag when subjected to increased yaw angles. This is why you slow down and use more fuel if driving your car in a strong sidewind. However, if a vehicle is designed to properly utilize existing ambient winds by having a plan airfoil shape, its aerodynamic drag will reduce to the point that in strong

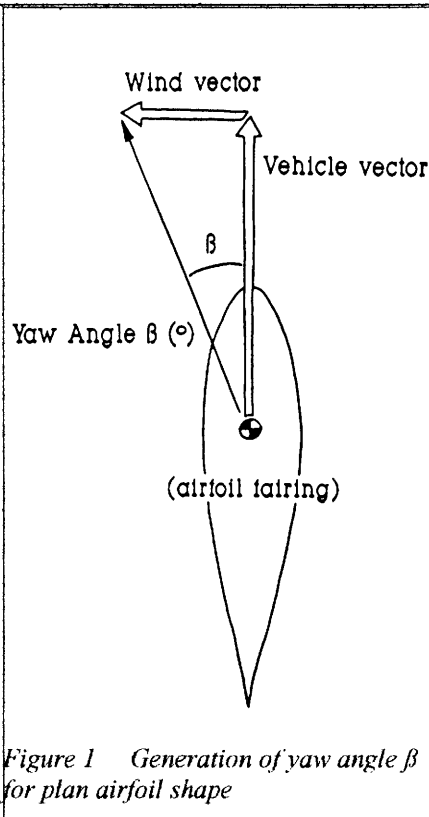

Figure 1 Generation of yaw angle  $\beta$  for plan airfoil shape

-enough wind it will become negative and begin to act as a sail by generating thrust (figure 2). The bottom curve in this figure is for a high-fuel-economy vehicle "Canadian Challenge" (world

record at 5691 m.p.g.) developed at the University of Saskatchewan; what is noteworthy here is that the  $C_d$  of the vehicle goes negative (i.e. net thrust is being generated) at the very low yaw angle  $\beta$  of 12 degrees.

This effect can have a definite bearing on HPV performance at high speeds. This is best shown by analyzing a hypothetical HPV under three conditions:

- 1) no wind
- 2) maximum legal wind from the rear, and
- 3) maximum legal wind at 90 degrees to vehicle travel.

We shall assume a fully faired HPV with a zero-yaw  $C_d$  of 0.15 and a frontal area of 4 ft<sup>2</sup> or 0.37 m<sup>2</sup>; these figures are most likely typical of the top competition vehicle today. The calculations will be done for a vehicle speed of 100 kmh (62 mph or 27.78 m/s). At this speed, rolling resistance will typically be about 5% of the aerodynamic drag so the rolling drag will not be included in these calculations.

At 100 kmh in calm conditions, this vehicle will require the following power to maintain a constant speed:

$$F_d = 0.5 \cdot \rho \cdot C_d \cdot A \cdot V^2$$

where  $\rho$   $\equiv$  density of air = 1.202 kg/m<sup>3</sup>

$A$   $\equiv$  frontal area in m<sup>2</sup>

$V$   $\equiv$  speed of vehicle in m/s

$$= 0.5 \cdot 1.202 \cdot 0.15 \cdot 0.37 \cdot (27.78)^2$$

$$F_d = 25.74 \text{ N (drag force)}$$

The drag power,  $P = F_d \cdot V$

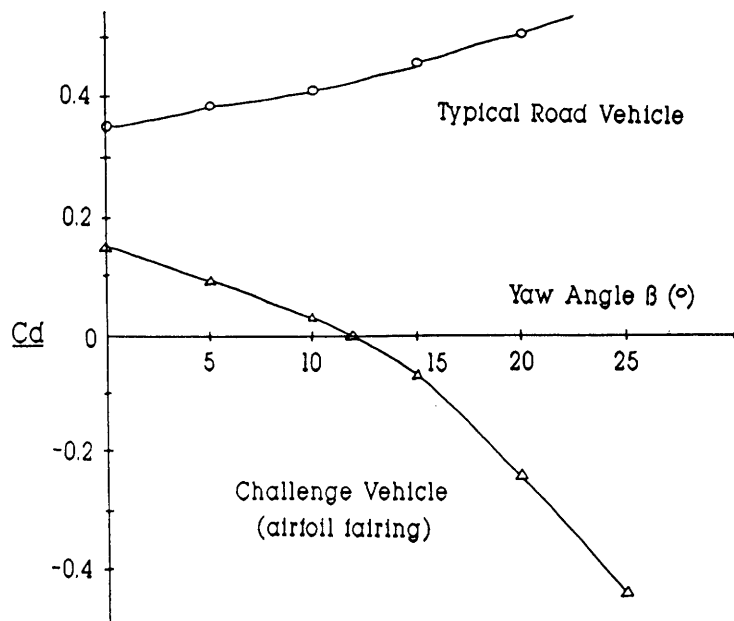

Figure 2  $C_d$  vs. yaw angle  $\beta$  for vehicles

$$= 25.74 * 27.78$$

$$P = 715 \text{ W or } 1 \text{ hp}$$

With a maximum legal wind of 1.67 m/s at the back of the HPV and assuming perfect coupling with the wind, the vehicle will be seeing an effective wind speed of only 26.11 m/s. With this change the power required to maintain 100 kmh with a 6-kmh tail wind becomes:

$$F_d = 0.5 * 1.202 * 0.15 * 0.37 * (26.11)^2 \\ = 22.74 \text{ N}$$

$$P = F_d * V \\ = 593 \text{ W}$$

The use of the tail wind has reduced the power necessary to maintain 100 kmh by 17%.

With a maximum legal crosswind of 6 kmh at 90 degrees to the direction of vehicle travel, a yaw angle  $\beta$  of 3.5 degrees is generated. With an optimized shape as shown in figure 2, the effective  $C_d$  at this yaw angle becomes approximately 0.10 or a reduction 33% from that with no-wind conditions.

When this new coefficient is added into the equation, the power required to maintain 100 kmh becomes:

$$F_d = 0.5 * 1.202 * 0.10 * 0.37 * (27.83)^2 \\ = 17.22 \text{ N}$$

(V has increased to the length of the resultant)

$$P = F_d * V \\ = 479 \text{ W}$$

The use of the maximum legal wind as a crosswind shows a total power reduction of 33% over calm conditions and a further reduction of 19% over tail-wind conditions.

This reduction of drag under crosswind conditions was experimentally demonstrated on the Challenge vehicle during the world-record run when the 25-kmh vehicle speed combined with a 15-kmh crosswind to generate an averaged yaw angle (over an oval track) to change the baseline  $C_d$  of 0.15 to an average value of 0.02! As a result, this negative-drag (thrust) effect at low yaw angles can have some very marked effects on HPV drag and speeds particularly at long-duration-event speeds of 50 to 80 kmh.

Assuming that any stability problems due to side forces in crosswind conditions can be properly addressed, an optimized airfoil-shaped HPV fairing will provide less drag in a crosswind condition than any other wind condition. With proper settings and ambient conditions at the limits, the use of a crosswind condition could result in the 200-m speed record being increased by up to 10 kmh with no additional power being necessary over previous efforts.

## References

Bosch Automotive Handbook, 2nd Edition, Robert Bosch GmbH, 1986

Aerodynamics of Road Vehicles, edited by Wolf-Heinrich Hucho, Butterworth-Heinemann, 1987

Various unpublished reports and data, University of Saskatchewan, 1980 to 1988

Tim Leier, 1146 College Street, #3  
TORONTO, ONT M6H 1E6, CANADA  
Phone: (416) 533-8650 (home)  
(416) 629-6461 (work)  
(416) 629-9742 (FAX)

*Tim Leier is a graduate professional engineer currently working for the Nissan automobile company. He has had experience in high-fuel-economy research vehicles (held world record at 5691 mpg), HPVs and solar-electric vehicles since 1981.*

## Reviews

### Recumbent Cyclist RCM 13 Nov.-Dec. 1992

The lead article is of a road test by Robert Bryant of the Easy Rider 3 Trike. (He found it to be well made, very comfortable and reasonably priced; he would like better brakes.) There are two further articles about Easy Rider three- and four-wheelers (including an MG-replica). There is a good correspondence section; three pieces on Team Cheetah's record; news of recumbents in general and of Lightning F-40's victories in the Whittier Grand Prix ten-mile race - 1st, 2nd, 3rd, 5th & 6th places. There is a homebuilder's corner about the Piranha Mk. IV, editorials, and lots of

advertisements. It's an attractive magazine.

*The Recumbent Cyclist* (\$22.95 in US)  
P.O. Box 58755  
RENTON, WA 98058-1755

## Cycling Science vol.4/1, fall'92

This is the first issue under the new post-Chet-Kyle publisher Larry Eder, but still with Ed Burke as executive editor. Christine Johnson is editor-in-chief (your humble hon. ed. of HP doesn't know what these titles mean). This issue is well-produced overall but with many small faults and typos that will no doubt not be allowed in future issues.

The first two articles are on engineering dynamics - on bicycle suspension systems and on front-fork damage during severe decelerations. There's an informative paper on a study of the dietary intake of female cyclist during series of racing days. (I've often felt that women are much more efficient than men at producing energy from food: this study shows that there are remarkable differences in intake between athletic women performing similar tasks). Finally there's an important article on the fatigue resistance of alternative methods of joining 4130-steel bicycle-frame tubes. As might be expected, lugged joints were most resistant to fatigue; brazed fillets gave typically 60% fewer cycles to failure; and butt-welded joints about 6.5% of the number of cycles to failure of lugged joints. Does this mean that butt-welded joints, at least in steel, should be avoided, or that brazed-lugged joints are better than they need to be?

*Cycling Science, Pike Creek Press, Inc.  
16 E. Portola Avenue, Los Angeles, CA  
94022, USA: \$22.97/yr.*

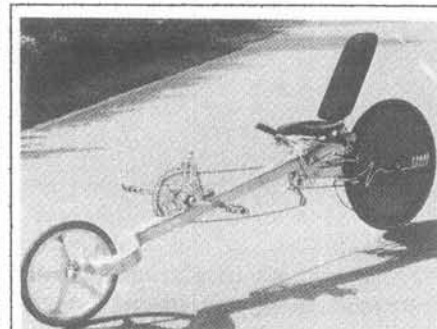

*DIMA cantilever-wheel LWB - Witten,  
Germany (Euro '92 Championships)*

## HPV NEWS FROM JAPAN from Toshio Kataoka Human Power associate editor

The indefatigable Toshio Kataoka sends reports of the many varied HPV and solar-powered events in Japan to HP and to HPV News. Here we extract from his "HPV News of Japan, vol. 3 no.2, Dec. 31, 1992" some items not covered in our current HPV News vol. 9/6/92. Toshio also sends much other material, including videotapes of HPV events in Japan, some of which we showed to a delighted audience at the Scientific Symposium in Yreka in August 1992, when Tory Sokomoto, winning pilot in the '91 Birdman competition and holder of the HPA distance record in Japan, provided the commentary. Human Power is the technical journal of the IHPVA and does not aim to compete with our HPV News as far as "straight" news is concerned. We do try to report news with special technical significance.

### Birdman Rally, 1992

We remind readers that the annual Japan International Birdman Rally ("International" should be read in similar vein to "World Series" in baseball) is for human-powered aircraft and gliders. A huge ramp is built out into Lake Biwa in Hikone, ending about 10m above the water. There is about a 5m take-off "run" to the precipitous drop. Gliders and planes are launched either solely by a supporting crew or with the added assistance of the pilot's feet. The date and time are set in advance: there is no waiting for good weather conditions. Tory (this is a nickname that means something like "Birdman") Sokomoto told me that his win was accomplished in a stiff breeze, perhaps 5-7 m/s, and rain. (The Gossamer and Daedalus flights waited, sometimes for months, for perfect conditions). There are no soft landings. Many planes break up as they leave the ramp and fall like stones into the lake. (How injuries are avoided is a mystery to me). The successful flights, even the winners, end up landing in the water and breaking up. The interest of the Japanese public is intense. The event is staged by Yomiuri TV before a large TV audience. In addition, 32,000 spectators turn up to watch. I

believe that we have not had one percent of that audience for any HPV event in the USA.

The following is my summary of part of Toshio Kataoka's report.

*Dave Wilson*

### Aeroscepsy wins both classes in the 16th International Birdman Rally

The Aeroscepsy team rebuilt its previous aircraft "Sinbad" as "Gokuraku Tonbo", with a new carbon-fiber propeller. The weather conditions were good: cloudy with a NW wind of 2-4 m/s. Pilot Hironori Nakayama took off successfully, and after the usual drop, tried to maintain an altitude of 6m at an air-speed of 6 m/s. However, he apparently hit a thermal, began to go out of control, and recovered by increasing his power and speed to 8 m/s. At 1800m into the flight he found himself close to a seaweed farm with hazardous fence-posts, and put on more power to get past them. A second seaweed farm then came into view at 2100m, and he wisely decided to come down on the water. Flight time was 7 min 32 s, and the distance of 2019.65m was a new record.

The Nihon University "Sakuzo-II" took off successfully. However, the starboard wing-tip panel kept lifting until it was acting as a spoiler, turning the craft unstably in that direction. It was about to crash when the panel dropped off. Pilot Yasushi Nishi put on more power and recovered his asymmetric HPA well, but soon became exhausted. His distance was 1226.04m.

A women's team, "Team Active Gals", flew "Hyper-Chick KoToNo Limited" under the piloting of KoToNo Hori to fourth place at 334.13m.

*(Editor's note: visitors to Japan will find that people are much more adventurous with the English language than English-speakers are with Japanese. Sometimes it seems that Monty Python has been circulating a Japanese-English dictionary).*

The launching of the gliders started at noon. The Aeroscepsy team converted an HPA, the "Super Gokuraku Tonbo 2" into a glider in only two weeks, and, using ground effect, won this event also, with an unpowered flight of 232.08m.

### Monohull beats hydrofoil

The second "Dream Ship Design Contest", a 200m standing-start sprint, was won by Cogito 1, a monohull with small side pontoons. The hull was coated with "riblet" film, and the pontoons carried small inverted-T hydrofoils to counteract propeller torque. Nevertheless, the craft rolled considerably. It was entered by Yamaha, whose multiple-hydrofoil boat "Phoenix II" won last year. Thirteen other hydrofoils, five other monohulls, and three catamarans entered, so it was felt that a win by a hydrofoil was assured. One of the hydrofoils, "Salud", had a crew of two, both water and air propellers, and a hydrofoil. Tokyo University entered a surface-effect boat with catamaran pontoons, an air-cushion fan, and a water propeller. However, victory went to Cogito 1. The wind was fairly high and the water choppy, conditions which some boats could not handle.

*(Toshio Kataoka's address is in the "mast-head" on p. 2).*

*[Toshio has also sent a collection of papers on HP helicopters from a recent symposium. Would a volunteer like to write a full review - perhaps up to three HP pages - for publication here? If so, please let me know. Dave Wilson]*



*Linear hand-and-foot-drive recumbent from HPV Nieuws, The Netherlands*

**International Human  
Powered Vehicle  
Association**

P.O. Box 51255  
Indianapolis, Indiana 46251-0255  
U.S.A.  
(317) 876-9478