

HUMAN POWER

THE TECHNICAL JOURNAL OF THE IHPVA

Vol. 8 No. 4

\$5.00

ISSUE NO. 28

Winter 1990/91

How to make a wooden propeller

by Philip Thiel

The following notes describe a method for constructing a propeller of epoxied laminations of marine-grade plywood, suitable for the low power and rpm of human-powered watercraft, and within the capabilities of one competent in elementary geometry and basic wood-working. We will illustrate the procedure as applied to the making of a three-bladed "right-hand" propeller, one which rotates clockwise in driving the boat ahead when viewed from behind the boat, with a 16-inch (400-mm) diameter and a 24-inch (610-mm) pitch, based on the Troost B3.35 model of 0.35 developed-area ratio to absorb 1/5-hp (150 watts) at 240 rpm and produce about 13 lb. (58 N) of thrust in open water at 4.2 knots (2.2 m/s) with 80% efficiency (1). The same procedure, of course, may be used for the construction of

(continued on page 12)

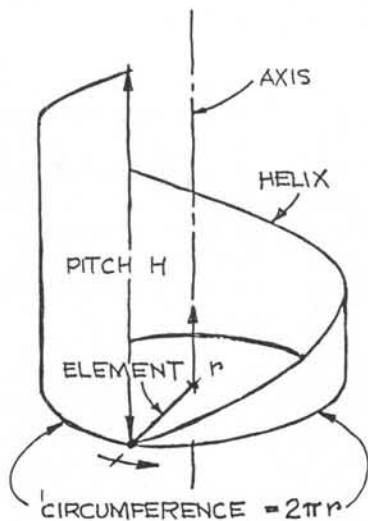
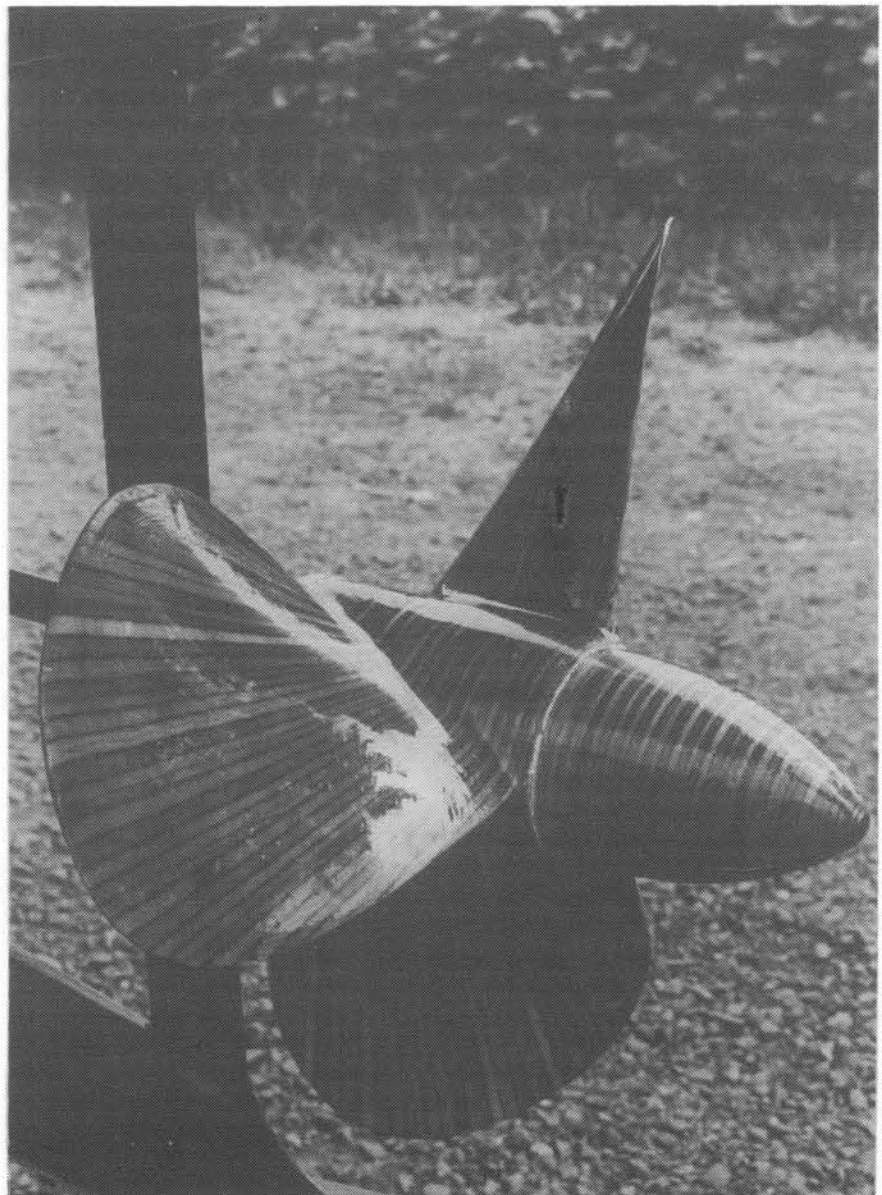

Figure 1. Helix



Laminated plywood propeller, 16" \varnothing x 24" pitch

Human Power

The Technical Journal of the
International Human-Powered
Vehicle Association

David Gordon Wilson, Editor
21 Winthrop Street
Winchester, MA 01890-2851, USA
(617) 729-2203 (home)
(617) 253-5121 (MIT)

Associate Editors

Toshio Kataoka—Japan

1-7-2-818 Hiranomiyama-Machi
Hirana-ku, Osaka-shi, Japan 547

Theodor Schmidt—Europe

Höheweg 23
CH-3626, Hünibach, Switzerland

Philip Thiel—Watercraft

4720 7th Avenue, NE
Seattle, WA 98105 USA

IHPVA

P.O. Box 51255
Indianapolis, IN 46251 USA
(317) 876-9478

Dave Kennedy	President
Adam Englund	Secretary
Bruce Rosenstiel	Treasurer
Paul MacCreedy	International President
Doug Milliken	VP Water
Glen Cole	VP Land
Glen Ray	VP Air
Matteo Martignoni	VP All Terrain
Theodor Schmidt	VP Hybrid Power
David Gordon Wilson	Executive VP
Allan Abbott	Board Members
Marti Daily	
Peter Ernst	
Chet Kyle	
Gardner Martin	
Matteo Martignoni	
Dennis Taves	
David Gordon Wilson	
Marti Daily	Executive Director

Human Power is published quarterly by the International Human-Powered Vehicle Association, Inc., a non-profit organization devoted to the study and application of human muscular potential to propel craft through the air, in the water and on land. Membership information is available by sending a self-addressed, stamped business-sized envelope to the IHPVA at the address listed above.

Members may purchase additional copies of *Human Power* for \$3.50 each. Nonmembers may purchase issues for \$5.00 per copy.

Material in *Human Power* is copyrighted by the IHPVA. Unless copyrighted by the author(s), complete articles or representative excerpts may be published elsewhere if full credit to the author(s) and the IHPVA is prominently given.

Special thanks to the authors, Marti Daily, Carolyn Stitson and Kim Griesemer, without whom this issue would not have been possible.

Editorials

This issue: volume 8 number 4

This issue carries some of the excellent articles on water vehicles gathered by the guest editors of the last issue, Phil Thiel and Theo Schmidt. Not all articles would fit in that issue, and we had a head start on this by using them.

That issue was numbered 8/1: a slip caused the first of volume 8 to be numbered 8/2. Steve des Jardins edited the Source Guide, and it was numbered, logically, 8/3. Hence this is 8/4.

Normally, contributions are sent to us for publication in a highly nonsteady stream, but with a degree of necessary pruning they seem to give us four issues a year. The watercraft issue shows what can be done when two dedicated editors apply their persuasion to the leaders in the field. We would welcome offers of other public-spirited people to edit future issues on special topics.

Research needed

Most HPVs in all media use pedals for power input. Yet I have never seen data on the drag of enclosed or open pedalling feet and legs. The drag has to be quite large, and a little research may lead to a large payoff.

You may wonder why I am so convinced that the drag of pedals, cranks and lower legs is large. Cold feet convinced me. Whereas I can keep all other parts of my anatomy warm and comfortable when I'm bicycling in the winter at temperatures down to below zero (F) (-18°C), my feet, despite two pairs of socks

and rubber overshoes and very good circulation, just get colder and colder. The only difference between my feet and my hands, apart from the work my feet are doing, which should make them warmer, is the rapid relative movement of my feet and lower legs. Convective heat transfer is proportional approximately to the square of relative air velocity, so that when one's foot is at the top of the pedalling circle it is going considerably faster than the machine, while at the bottom of the stroke it is going slower, but the average heat transfer is much higher than on one's hand, for example. The power losses due to drag increase as the cube of the relative velocity.

If this is the reason my feet get cold, and it agrees with the data, then we can infer that the aerodynamic drag, which is closely related to heat transfer, must also be high. Here's a topic for a master's or doctoral thesis that would be challenging and could offer racers a considerable reduction in drag, if appropriate fairings (or faired footwear) are designed.

Flat-tire directional performance

Another area of needed R&D is the steering performance of wheels with flat tires. I have had many slow-speed and medium-speed blowouts in front tires of bicycles, and because I survived them I convinced myself that I had developed survival skills to cope with any emergency. One blowout dropped me from my Moulton SpeedSix right in front of a moving bus, but it was the driver's skill and the bus's brakes that saved me, not any ability of mine. This September I had my first high-speed front-tire blowout, on a steep hill in northern Vermont, and as I was wearing far too little on my hands and legs I lost a great deal of skin. (And trying to ride in the following weeks with my left butt off the recumbent seat did something extremely painful to pinch a nerve exiting my spine). When the tire burst the bike shot off to the left, which would have put me under a passing truck or into an oncoming car if either had been in the right place at the wrong time.

Many of you could top my experience—join in any group of experienced HPV people or bicyclists and you will hear similar stories. But it doesn't have to be that way. We don't have to ride or drive sweetly running machines that convert in a fraction of a second into dangerous assemblies of sharp metal. Riders in faired

In this issue—

<i>How to make a wooden propeller</i> by Philip Thiel	1
Editorials	2
Letters to the editor	3
Reviews	3
<i>Low-energy boats</i> by Theo Schmidt	4
<i>Dragonfly III</i> by Daniel Hostetter	5
<i>Outboard Alternatives</i> by Philip Thiel	6
<i>Rear-wheel-steering basics</i> by John C. Whitehead	9
<i>Bicycle fairings and efficiency</i> by Dave Kehoe	15
<i>The Seacycle Story</i> by John Foley	19

recumbents have shown many times that they can survive a high-speed spill without receiving a scratch—but I'm not sure that I want to be skidding on my side enclosed by a fragile fairing in a road full of massive high-speed motor vehicles. I'd rather be able to come to a controlled stop, meaning that the steering is good enough to keep me upright. A general principle of design is to produce devices that "fail-soft", not "fail-disastrously". So another topic for research is the behavior of single-track vehicles after the tire on the steered wheel has blown, and the development of tires that stay on the rims and give good directional control.

Envy of automotive developments

Ellen and I bought a new car last year. The only vehicle we could get in the type we wanted came "loaded". I grumbled that I didn't want the automatic door locks and the powered windows and the cruise control and so on. But—you've guessed it—I've found them really rather delightful. I began musing as to why we have so few innovations in commercial HPVs. We can blame the suppression of recumbents in the thirties on the dead hand of regulation from the UCI. But in today's vibrant bicycling climate—in which mountain bikes in their second coming are setting extraordinary sales records—only digital odometers, pre-set multi-ratio derailleur gears and new forms of handlebars could be regarded as true innovations.

The subsidy to car drivers—now being assessed as being between \$5000 and \$10,000 per year in the US—has to be the dominant factor. It has certainly stifled innovation in competing fields of transportation: buses, mass-transit and railroads haven't changed in essentials in the last fifty years, and remain viable, in general, only if they themselves receive large subsidies. If—a large if—our politicians eventually realize that subsidizing automobiles is costing far more than the subsidies themselves, and if they remove part or all of the subsidies and thereby restore some free-market competition, HPVs would be in the mainstream and technology would advance rapidly. Then we would see a stream of innovations comparable to those that make people want to buy new cars every year or two. But, even then, could we really get HPV cruise control?

Our associate editor in Japan

Toshio Kataoka has agreed to take on the title of associate editor of *Human Power*

in Japan. He has been sending us invaluable news and reports, and we wanted to recognize his generous contributions. Welcome and thank you, Toshio!

Correction

We apologize to Bruce Sewart for misspelling his name in HP 8/1, in The Spinsurfer story.

—Dave Wilson

Letters to the editor

Swedish hydrofoil

In Sweden a two-person hydrofoil, the AF Chapman II, has been built by people from Chalmers university. They pedal back-to-back, and so far they have reached almost 12 knots (6 m/s). The aim is the European championships for human-powered boats, to be held in Sweden for the first time in May 1991. Last year 27 boats and about 300 participants from twelve different countries competed. Chalmers University had the only hydrofoil and won the innovation prize. This year it is rumored that there will be several more hydrofoils. The AF Chapman II weighs 54 kg and took 3000 hours to build.

Your HPV-cyclist,
Mats Nilsson
Hermelinsu 151
902 38 UMEA
SWEDEN

Good suspension for recumbents

You guys are doing a great job. My spirits jump when I get your (our) publications in the mail. . . . We have been riding recumbent bikes with a good working suspension system for a couple of years now. We took them on a terrific 500-mile tour in Italy, Corsica and Sardinia this past summer.

Steve Smith
2 Acoma Street #5
Denver CO 80223
USA

Steve not only sent in a donation to the IHPVA but offered to write something on the recumbent suspension system.

—Ed.

Reviews

Fahrradpatente —"Cycle patents" assembled and discussed by Ulrich Herzog (in German). Moby Dick Verlag, Kiel, 1984.

This delightful paperback was sent to me by John Stroyk, to whom I am indebted. I am a strong advocate of looking at patents before claiming originality in anything, and perhaps even before one starts brainstorming. Finding the patents to examine is a fairly tedious business, better accomplished by commissioning experts. But here is a book of 191 pages in which about eighty HPV patents are reviewed. (The German word *Fahrrad* is not restricted to bicycles). US, European and British patents are displayed in seven principal topic areas (transmissions, brakes, and so forth). Generally the drawings are on a page to the left, and a description of the concept and a discussion are on the right. The period is supposed to be the last two-hundred years, but most of the patents were issued from 1878 to 1910. Two aspects give me a little concern. There were presumably thousands of cycle-related patents issued in this period: how were these representatives selected? My reading ability in German is not good enough to find an explanation in the introduction, but the author is to be allowed a license, and presumably he chose what interested him. Alas, the author perpetuates a myth in a historical table he reproduces: that of the Compté de Sivrac and his nonexistent precursor of the bicycle. Historical myths are like many-headed hydra: they are debunked, exposed and de-frocked, but they appear elsewhere undamaged but damaging.

These are small criticisms. We are grateful to have this excellent little book available, and to learn from the incredibly dedicated and highly skilled efforts of the pioneers.

Cycling Science, vol. 2/2, June 1990

The cover photograph is of Francis Faure breaking the world hour record on the recumbent Velocar in 1933. It emphasizes something that many re-writers of HPV history haven't checked: the Velocar, in the form used by Faure to break a whole range of records, was an unfaired recumbent bicycle. The photograph is part of the first article, by Arnfried Schmitz, a retired engineer of Lioux-Gordes, France, on HPV

(continued on page 4)

Low-Energy Boats

by Theo Schmidt

This issue is mainly about some types of low-energy boats. Until recently, all boats were "low-energy", but the internal-combustion engine has changed this. In a manner which is exactly analogous to the development of cars on land, modern power boats have become a source of noise, pollution, and danger. They cause waste, annoyance, and erosion. Their brash success has killed off traditional boat design and lifestyles, and previously intact eco-systems. Viewed in a long-term perspective, these disadvantages far outweigh the short-term advantages for individuals using such craft.

But the times are changing! Increasing environmental awareness and corresponding legislation are making low-energy philosophies more attractive and helping to re-introduce proven concepts and develop exciting new ones. The following summarizes some old and new "low-energy" technologies:

Sailing boats are a special case. Although designed to require as little energy as possible for propulsion, the powers and forces passing through rigging and hull are considerable. Some craft are able to move many tons of cargo using very little manpower, e.g., the large Thames Barge, which was traditionally worked by a man and a boy and could carry 120 tons. Modern designs using wingsails or wind turbines can even be controlled remotely or at the touch of a button. Sailing craft can be remarkably fast, and they give pleasure to countless sailors worldwide.

Animal-powered barges were once in widespread use. Efficiency was mostly gained by operating at very low (walking) speeds, where the resistance in the water is extremely low due to the absence of gradients and mechanical friction and because power increases or decreases with at least the third power of the speed. A single animal can pull a barge weighing 100 tons or more.

A "high-speed" example of animal-powered efficiency is also available: over a century ago, several "Fast Packet Boats" plied the Lancaster Canal between Kendal and Preston, carrying up to 120 passengers at average speeds of nearly 8 knots (4 m/s) with the power from two horses! Although the horses were changed every 4 miles (6.5

km), the passengers in the 75-ft-long (23-m) and 6-ft-wide (1.8-m) vessels could travel quicker and more comfortably than on the roads of that period. A modern ferry would use perhaps 100 times the power for the same result.

Human-powered boats are the oldest means of transport known to Man. Even today, some peoples still use wooden dugouts which they paddle on quiet rivers with remarkable efficiency. Other peoples developed skin boats: kayaks, baidarkas, and canoes, using these for transportation, hunting and waging war. Such boats have shaped the history of many American areas, in contrast to the rowing craft or even early galleys around Europe, which were probably sailed whenever possible.

In the Orient, too, junks and the like were and are often driven by a long sculling sweep called a *ylch*, allowing single persons to propel rather heavy vessels at about walking speed.

Other traditional uses include ferries worked by pulling them across rivers along a stretched rope. To this day, a three-car ferry crosses the Rio Grande, pulled by six men.

Today, many people are re-discovering the joys of human-powered boats, not so much as a means of transportation, but for fun, fitness, and adventure.

Steam boats: Although the steam engine (and even more the steam turbine) is a concentrated source of power, its efficiency is limited, and the required boilers are heavy and large. Therefore, steamboat hulls have had to evolve to be efficient, and their elegant lines bear little resemblance to the pseudo-speedboat-type hulls so prevalent today.

Electric boats evolved in much the same manner as steam boats. Displacement hulls easily carry the heavy lead batteries. Because of the limited range and the high cost of these batteries, electric boats never became very popular in an age where coal was cheap and electricity a luxury.

Today's electric technology has changed this. Modern electric boats work admirably in all conditions, except where sustained high speed is called for, e.g., offshore rescue boats. They can be rendered partially or totally autonomous by fitting smaller or larger areas of solar panels.

Solar boats represent the newest development in our list. They combine many of the advantages and characteristics of both human-powered and sailing boats. They work even in cloudy and windy climates, except perhaps in high-latitude winters. The problem that remains is still the high cost of solar cells. Although well-affordable as luxury items, those people in developing countries who could best use such boats are least able to pay for them.

All the listed craft have one thing in common: the source of power is limited and not very concentrated, but can be derived from non-polluting, quiet sources. It is precisely this lack of cheap high-power which calls for efficient, elegant solutions in hull design and renders such craft worthy flagships in our new environmentally conscious age.

Theodor Schmidt
Höheweg 23
CH-3626, Hünibach
SWITZERLAND



Reviews

(continued from page 3)

history. The drawing of Charles Mochet's invention at the head of his article reveals something else of great interest to me: Mochet designed a long-wheelbase recumbent, but it was modified to a medium-wheelbase form for Faure. The bottom bracket was almost over the front wheel, a design finding renewed favor nowadays. Schmitz brings a wealth of new details to the story of French recumbents and other HPVs, partly from interviewing members of pioneers' families, and he gives some information that may require further revisions in cycling history. The photographs are delightful.

There are many other useful articles and short reports on, for instances, hill-climbing when sitting, standing and using toe clips; carbohydrate replacement in prolonged exercise; and energy use in bicycling.

Volume 2 no. 3, September 1990

A principal article is on the effect of drafting and aerodynamic equipment on energy expenditure during cycling, by James M. Hagberg and Steve D. McCole of the University of Maryland. Chet Kyle has a useful article on quick calculations of

(continued on page 15)

Dragonfly III

by Daniel Hostetter

To understand the design concept of this craft, it is necessary to first understand Steve Ball, its creator. Steve is an innovator-cum-laude. His competitive racing approach to design is simple: think of something absolutely new, never tried before, not even thought of before.

This approach to competitive design has created a lineage of racing successes. *Dragonfly I* was a 850 cc hydroplane that established a world's top speed record in its class. The long stinger hull, stubby-front-wing configuration still remains unique in racing design.

Dragonfly II continued this design philosophy when Steve designed the world's fastest human-powered linear-drive vehicle. The rider, Richard Bryne, lay prone with his head down, looking through a series of mirrors. The drive mechanism was a linear sliding-grips-and-pedals arrangement. Its final success was winning the IHPVA World Championships at Indy in 1983.

So I am sure you get my drift by now, when I say that *Dragonfly III* is once again one of Steve's far out racing design concepts. The craft may look very strange, but the principle is very simple: have the least amount of the vehicle travel through water (large force needed), and the greatest amount travel through air (smaller force needed). When *Dragonfly III* is at speed, it is lifted almost entirely out of the water by a cushion of air pressure.

Steve's S.E.S. (surface-effects ship) is a catamaran design with a light rubberized canvas deck and water-contouring air-flow

seals on the front and back. As the rider pedals, about 1/3 of his effort is used to drive a centrifugal fan that forces air into the 40-sq. ft (3.7-sq. m) cushion area beneath the canvas. The pressure need increase only 1.1" of water (3.00 Pa) to hover the craft. A static hover with no leaks requires only .04 horsepower (30 W). At this time the hulls will have risen from 7" (180 mm) of immersion to under 1" (25 mm) while supporting the craft's weight of



Richard Byrne has been the main engine for both *Dragonfly II* and *III*. At this point, the craft is just about to rise past "hump." Hump is the transition from being in the water to being on top of it.

75 lb (34 kg), plus a 170 lb. (77 kg) rider.

Early hydrodynamic tow-tank testing done by Dave Carroll, Dan Hostetter and Steve indicated the craft would have 13 lbf (58 N) of drag at 16 mph. This is within the capacity of a human being. In fact, *Dragonfly III* appears to have already exceeded 16 mph (7 m/s) on two back-to-back runs in our 200 ft (61 m) timing trap on Lake Miramar in San Diego. However, only officially timed runs mean anything.

Light weight is important, so the hulls

and cross members were constructed from a sandwich of 4 oz (124 g) fiberglass skin and a 1/4" (6 mm) urethane foam core [4 lbm/cu ft (64 kg/cu m) density]. The hulls are 151" (3.8 m) in length and are separated by approximately 45" (1.1 m). They are a hollow triangle shape with 5-3/4" (146 mm) width at the top and the apex of the triangle 11" (280 mm) down. Only an inch (25 mm) of the apex is immersed in the water at speed.

Steve designed and built a fan-flow test chamber which he used to test the efficiency of several different configurations. The high-speed (6,000 rpm) cushion-pressure propeller design was discarded in favor of a centrifugal-type compressor.

This blower features curved air-foil blades, intake flow straighteners, and a ring diffuser. It is driven by a round urethane belt coming from the derailleur pulley. This cushion fan produces an efficiency of 65% at 1600 rpm. Steve was helped by Mike Burz and Joe Wiederholt on this design.

Homer Stewart, a retired Cal Tech professor, gave Steve the design for the 11-ft.- (3.3-m-) diameter air propeller. It was constructed from 4 lb/cu ft. (64 kg/cu m) density urethane foam and covered with a silky fiberglass. The spars were

reinforced with unidirectional "S-glass". When the rotational speed is between 80 to 90 rpm, this design exhibits an efficiency of 85%. There is only one rudder, and it can be raised out of the water flow to further reduce drag.

Dragonfly III had its first test of competition at the 1988 IHPVA Championships held in Visalia, California. We knew the performance of *Dragonfly III* would be reduced by the rough-water surface conditions; however, our rider, Richard

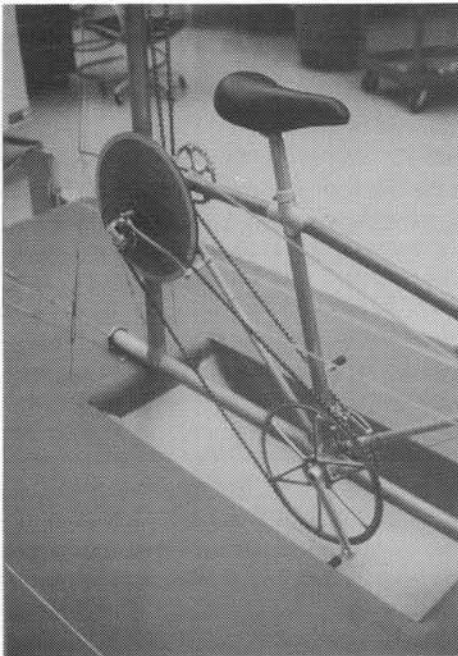

Aluminum tubing was used exclusively in the construction of the frame. The starboard drive went through the derailleur then to the belt pulley which drove the cushion fan. The port side drove the 11' diameter air prop.

Bryne, reached a speed of 13.16 mph (5.9 m/s) in the 100-meter course which was sufficient to win second place behind Alan Abbot's *Flying Fish*.

Right now, Steve Ball and crew are waiting for that perfect, glassy morning complete with official timing clocks to demonstrate what *Dragonfly III* can really do.

Stand by.

Daniel K. Hostetter
7432 Salizar Street
San Diego, CA 92111 USA

Daniel Hostetter has a degree in mathematics; he met Steve Ball while working as a research engineer at Lockheed Missile and Space Corporation. He has assisted Steve in the construction and testing of his watercraft and is presently employed as a craftsman at Nissan Design.

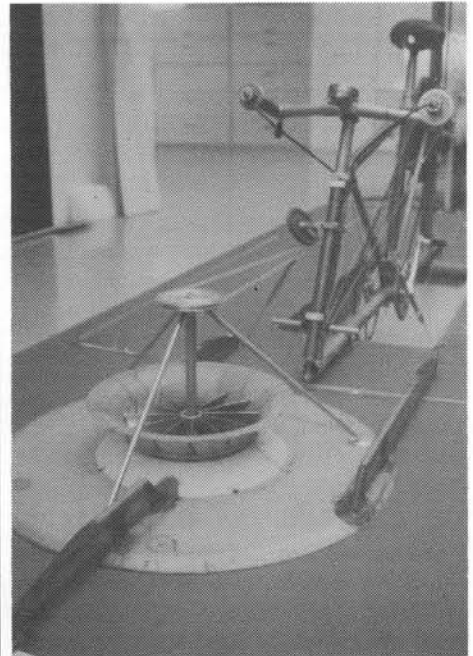

This is the final design of the cushion pressure fan as it was installed. Twist controls on the handlebars could raise or lower the rudder or the front and back seats.

Outboard Alternatives

by Philip Thiel

Is there a market for a reliable, lightweight pedal-power propulsion unit that can be attached to a variety of existing watercraft? Such a device would suit the needs of those interested in a quiet, healthful means for recreation on the water, as an alternative to the use of the popular gasoline-powered outboard motor, with its noise, odor, vibration, and pollution. Prototypes now exist for two such appliances: one intended primarily for trolling, and the other for cruising.

Jim Schneider's *Pedalroller* (1) features a three-speed bicycle power train, and 360-degree wrist-controlled steering. Mounted on an 11-inch- (280 mm-) high bow or stern transom, it requires only a seat and backrest for the operator. A sprocket-chain drive delivers power from the pedals through a bevel-gear vertical shaft to the propeller. Total weight of the prototype is 21 lb (9.5 kg). Figures 1, 2, 3 and 4 illustrate the device in terms of its patent drawings, while the photo shows the prototype as applied to a 14-foot (4.27 m) Jon boat.



Pedalroller prototype by Jim Schneider

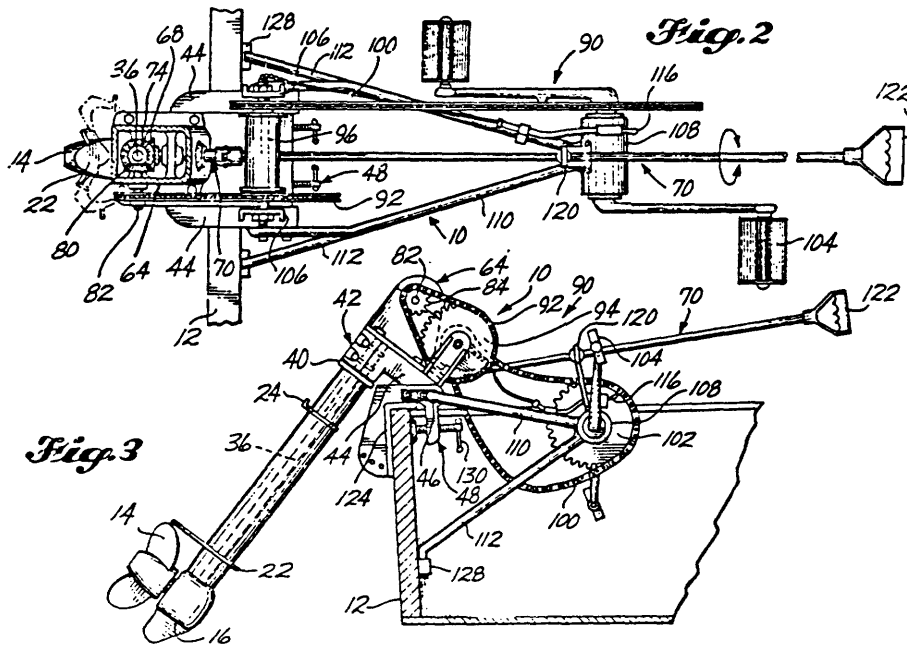
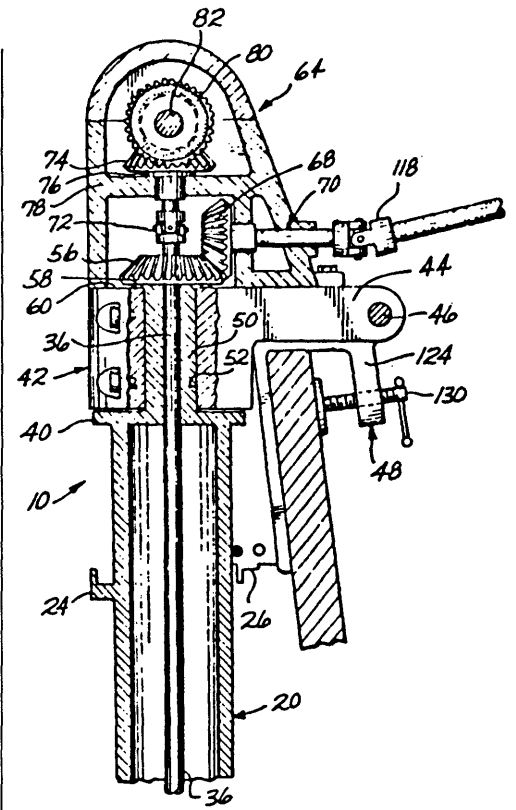
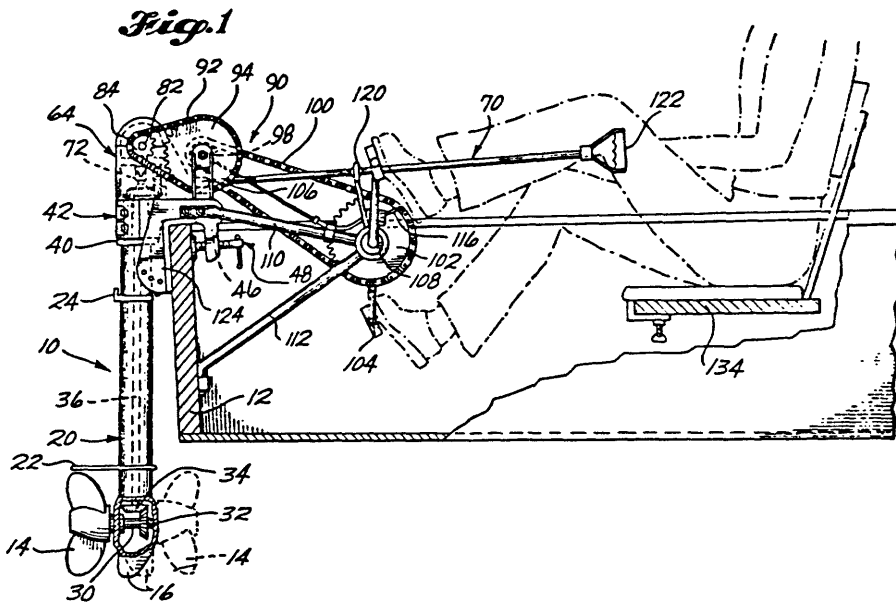

Pedaltroller patent drawings, US patent No. 4,427,392

Although intended primarily for trolling, in application to this boat the inventor claims the average person can achieve speeds of 5 to 7 mph (2 to 3 m/s) and easily cope with head winds. Because of the 360-degree steering, the maneuverability is especially good.

Experimentation with propellers and gearing is continuing, along with the development of 8- to 10-foot (2.4- to 3-m) one-person tractor-propelled watercraft.

The inventor is looking for investors.

Bob Benjamin's *Pedal Boat Drive* (2) incorporates a forward-facing seat and pedal assembly that clamps to a thwart and a clamp-on drive assembly which adapts to different transom dimensions. The former weighs 34 lb (15.5 kg) and the latter 18 lb (8.2 kg). The right-angle 1:1 gear box with pedals transmits power through a telescoping shaft to the swivel-gear sprocket-chain drive system on the

transom. The drive chain is completely enclosed in twin tubes in a V-configuration, and connects with a 16-inch- (406-mm-) diameter three-bladed propeller. The drawing shows the assembly of both components and identifies the materials. Photographs illustrate the assembly, its application to a 14-foot (4.27-m) fishing boat and the propeller. Trials using this boat over a 200-foot (61-m) course with two people aboard for a displacement of 510 lb (232 kg) gave the results shown in the accompanying chart. The designer notes that in application to a 17-foot (5.2-m) canoe with two people aboard the speed was 1.2 mph (0.5 m/s) faster, the operator in both cases being an "average non-athletic" person. The designer also comments that when installed on a 12 to 14-foot (3.6 - 4.3-m) fishing boat with four or five people on board an average person is able to pedal at trolling speed all day long and that even small children do surprisingly well. Steering is accomplished with the use of hand levers on both sides of the seat which, connected by chains to the final-drive assembly, turn it from side to side, giving quick and positive control.

This *Pedal Boat Drive* is available for \$695, shipped via U.P.S. or parcel post. The cast aluminum propeller is also available for \$85, and the gear box for \$145.

Footnotes

(1) Jim Schneider: 10402 100th St., E., Puyallup, WA 98373, (206) 848-6128.

(2) Bob Benjamin: Circle Mountain Industries, Inc., Box 1148, Fort Benton, MT 59442, (406) 734-5416.

Philip Thiel
4720 7th Ave., N.E.
Seattle, WA 98105 USA

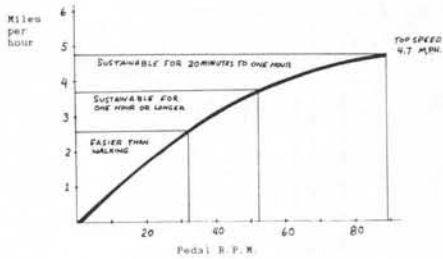

Pedal Boat Drive performance, 14-foot aluminum "V" hull fishing boat, 510-lb load

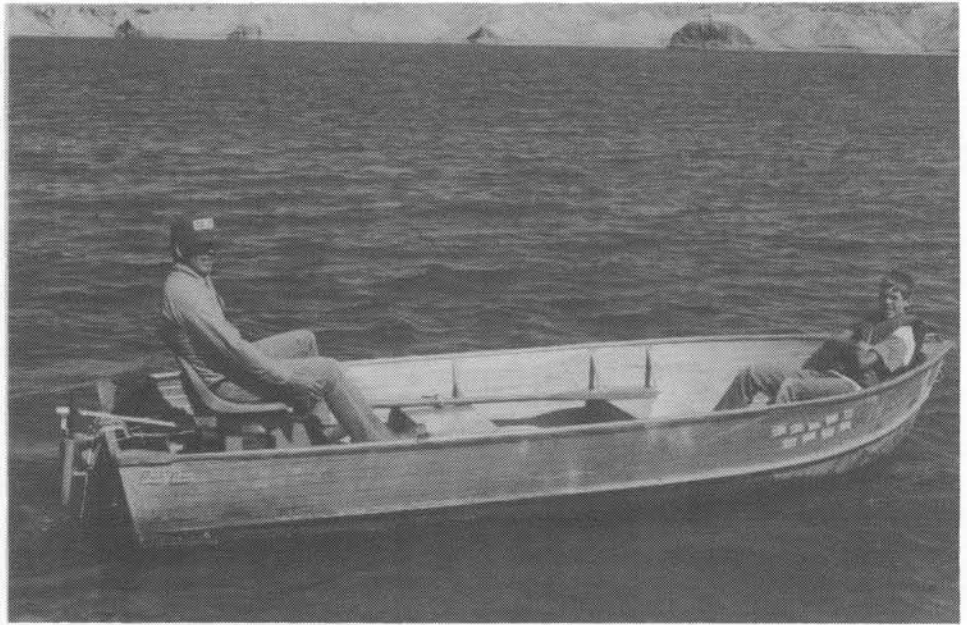

Bob Benjamin's Pedal Boat Drive

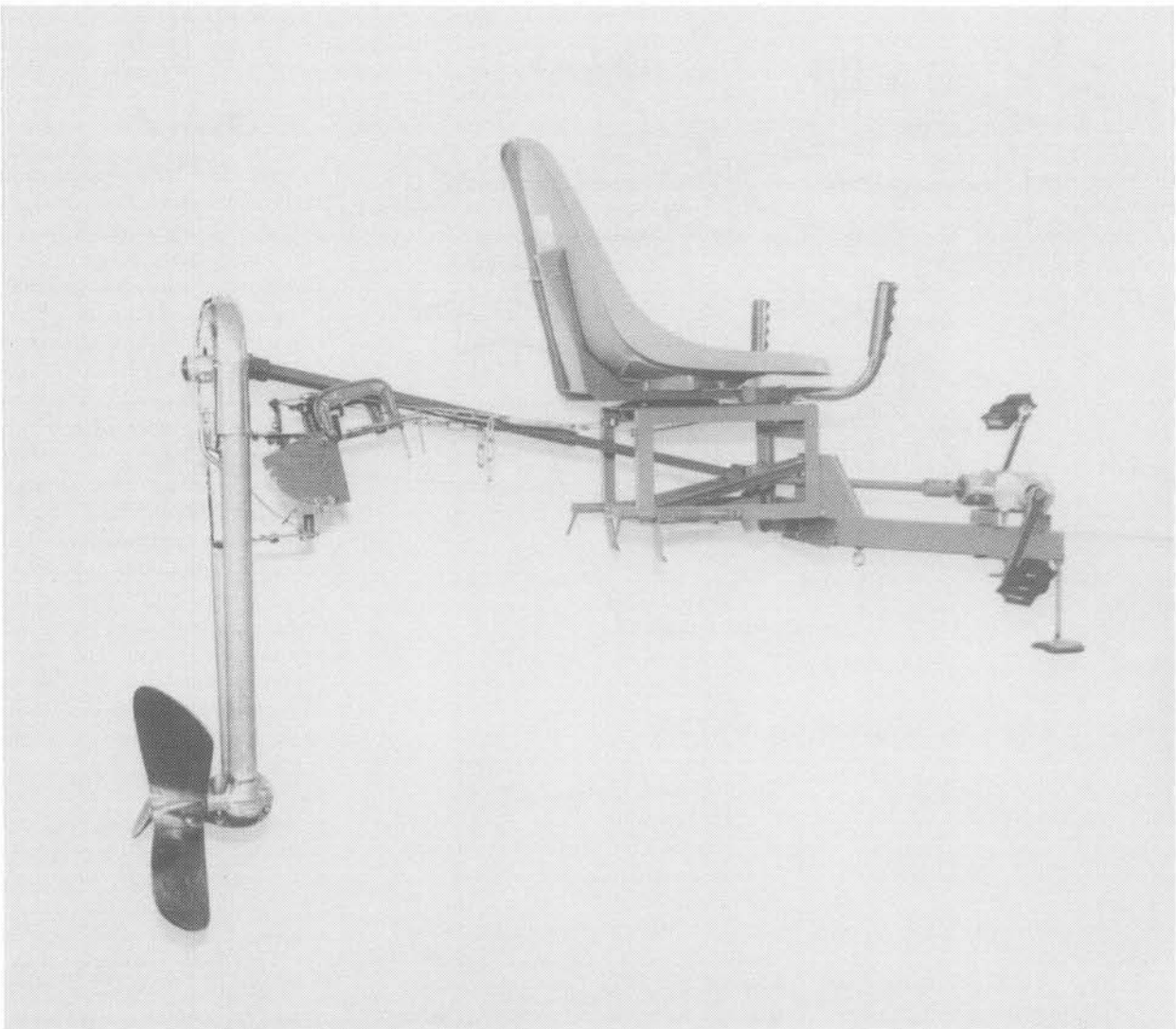

Circle Mountain Pedal Boat Drive, Model CM-20

Rear-wheel-steering basics

by John C. Whitehead

This article is a summary of what is known about rear-wheel-steering (RWS) dynamics. Since a complete treatment would require many pages, it appears as a collection of concepts which are explained with minimal supporting evidence. Although mathematics and experimental data are both absent from this article, everything included is supported by one or more rigorous technical papers. The references are listed for completeness, but the intent is for the reader with practical questions to benefit from this article alone. I have found it productive to understand front-wheel steering (FWS) and to make direct comparisons between FWS and RWS vehicles in various situations. This and other thought processes which have led to my present understanding of RWS are, I hope, conveyed here.

Most people who have observed or thought about RWS vehicles know that "RWS is unstable." However, this is not always necessarily true, and instability does not always imply uselessness (a bicycle with no rider is unstable because it will fall over, but who cares?). When one considers a dynamic system, statements about response, stability, and control are incomplete unless the system of interest is precisely defined, including the degrees of freedom, and what the inputs and outputs are. For lateral vehicle dynamics, the input comes through the steering mechanism, and the main output of interest is the path of the vehicle on the road. It may be less obvious what the degrees of freedom are, but they include yaw rate (rotational velocity about a vertical axis), and lateral velocity. That's right, road vehicles do not in general move exactly "forward" along their longitudinal axis. The lateral velocity component is a tiny fraction of a vehicle's forward speed, but it is the key to understanding much about vehicle dynamics.

Five different RWS systems are considered here, each of which is a precise way of representing a particular mode of operation of RWS vehicles. They are:

1. steer-angle fixed, steady-state cornering;
2. steer-angle controlled, performing maneuvers;
3. steer-angle free to move ("hands off" riding);
4. steering-torque input to control

steer angle (person steering); and

5. RWS vehicle with only two wheels.

Cases 1-4 are assumed to be multi-track vehicles, i.e. more than one wheel on at least one end of the vehicle. It is useful to realize that (1) is a special case of (2), and (3) is a special case of (4) when the torque is zero. Discussion of RWS bicycles (5) is included for completeness.

1. Steady-state cornering

Imagine both FWS and RWS vehicles moving in steady-state turns, as diagrammed in Figure 1. Lines drawn perpendicular to each tire's rolling direction intersect at the center of the turning circle. The solid lines indicate the obvious low-speed behavior, wherein the FWS turn center is along the extended rear-axle line, and the RWS turn center is directly to the left of the front axle.

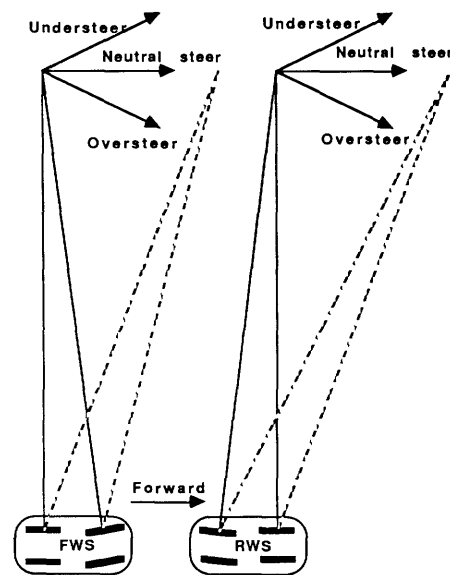

Figure 1. Front-wheel steering and rear-wheel steering vehicles turning left. Turn center moves forward and may move closer to or away from vehicle as speed increases. RWS vehicles may be made to understeer or oversteer, just as FWS.

A cornering vehicle must be pulled toward the center of its turning circle by a centripetal force, which increases as the square of forward speed for a constant-radius circle. The centripetal force is the resultant of lateral tire forces, which are

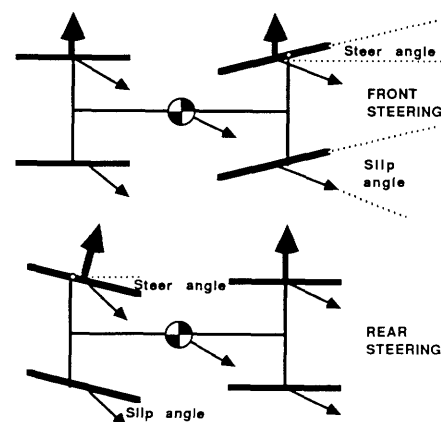

Figure 2. FWS and RWS vehicles turning left. Angles are exaggerated, thin arrows show local velocity and thick arrows indicate lateral tire forces.

associated with tire slip angles, the angle between a tire's natural rolling direction and its actual velocity vector as shown in the magnified view of Figure 2. The small lateral velocity component is due to tire deformation by the lateral force, not sliding at the tire-road interface as the name "slip angle" may at first imply. Lines toward the turn center must be perpendicular to each tire's actual velocity vector. Therefore, the turn center moves forward with increasing speed, as shown by the dashed lines in Figure 1. For high-speed HPVs and automobiles on the highway, the turn center is forward of the front axle for FWS as well as RWS, because tire slip angles are greater than the steer angle [16]. The fact that the high-speed turn center is forward of the front axle for all vehicles means that the vehicle's longitudinal axis is turned slightly inwards toward the turn center, which requires that the vehicle's sideslip (lateral) velocity is toward the outside of the turn.

As speed changes, the turn center does not just move fore and aft. It may also move toward or away from the vehicle, because the front and rear slip angles can change by different amounts, due to imbalance in the front/rear weight distribution relative to the tires' cornering-force-generating capabilities. If the turn center moves toward the vehicle as speed increases, the cornering circle gets smaller. Such a vehicle would appear to steer too tightly while accelerating in a turn with a

constant steer angle, so this condition is called oversteer. Above a critical speed, an oversteering vehicle will spiral into ever-tighter cornering and spin out, even with the steered wheels pointed straight ahead. Understeer is just the opposite of oversteer as Figure 1 indicates, so an accelerating vehicle with a constant steer angle would corner less tightly. Neutral-steering vehicles have a perfect front/rear balance, i.e. equal weight divided by cornering force capability (technically, the neutral steer point is at the center of gravity). For example, a tricycle with three identical tires should have 1/3 of its weight (including rider) on each wheel for neutral steering. A small amount of understeering is generally preferred, which means that a tricycle with two front wheels should have over 70% of its weight on the front if all tires are identical. If the rear tire has more contact area than a front tire, then understeering would occur with 1/3 of the weight on the rear.

Given the above factors that determine understeer/oversteer, it is easy to see that these phenomena are independent of which wheels are steerable. An RWS vehicle with a constant steer angle is just like an FWS vehicle with the body yawed relative to the chassis. The author has built and recorded maneuvering data from a RWS three-wheel car which understeered with a 80/20 weight distribution [14]. Note that forklift trucks have a large counterweight over the steered wheels so when unladen they actually do oversteer if driven in the nominal RWS direction [10]. There will be understeer if the vehicle is turned around, not because the steering is changed to FWS, but because the f/r weight distribution is reversed. The problem which makes RWS vehicles unusual does not occur during steady-state cornering, so it is important to avoid saying "oversteer" when you mean the handlebars were turned too far ("overshoot" is the technical word).

2. Maneuvers in response to steer-angle change

Consider a vehicle following a straight path. If the front wheels are suddenly steered to the left, the front of the vehicle accelerates to the left and it begins to follow a curved path due to the resulting yaw rotation. If a left turn is desired with RWS, the linkage must steer the rear wheel(s) to the right. Then, the rear accelerates to the right and the vehicle also begins to follow a curved path to the left due to the same yaw rotation as in the FWS case. Thus, the transient response to steer-angle control

should be understood to have two parts: the initial lateral motion at one end of the vehicle, and the path change due to yaw rotation. RWS is unusual because the initial motion at the rear is in the opposite direction to the desired turn. At high speeds, however, this reverse action becomes a smaller part of the overall transient response because lateral motion resulting from yaw rotation is essentially amplified by forward speed, and there is no fundamental difference between FWS and RWS yaw responses to steer-angle inputs [16].

Figure 3 shows transient lateral position of a vehicle center of gravity [from ref 16]. At low speed, the RWS vehicle clearly has initial motion in the direction opposite to the desired turn, but the RWS response becomes more like the FWS response as speed is increased. Therefore, to the extent that riders can maintain precise control of the steer angle of the steered wheel(s) at all times, RWS vehicles should become less unusual as speed is increased. To this end, it is helpful to have a very precise steering linkage with high stiffness and no backlash, and the frame must be rigid for the same reason.

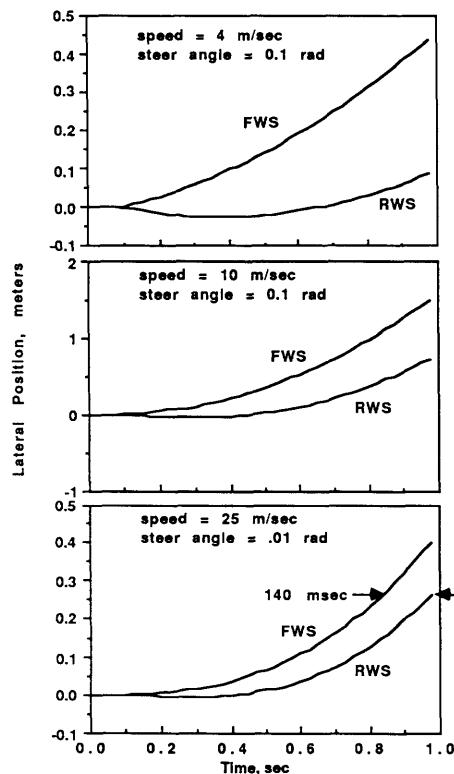

Figure 3. Calculated lateral position responses to a steer angle input, for a small road vehicle.

3. Hands-off dynamics

In reality, riders do not steer by continuous precise steer-angle control. It is desirable for vehicles to go straight if attention to steering is momentarily interrupted. In order to analyze this mode of operation, the steer angle is a degree of freedom, influenced by steering torques. The major steering-torque component in the hands-off vehicle is due to lateral tire force, with caster offset ("trail") as the moment arm. It is well known that the steering geometry of FWS vehicles is configured such that the tire-road contact patch trails behind the steering axis, so the lateral tire force tends to return the steered wheel(s) to the straight-ahead position, as indicated in the upper diagram in Figure 2. This self-centering caster effect in FWS vehicles is due to both transient and steady-state restoring torques.

Whether there is a "correct" steering geometry for the RWS case is less obvious, because transient and steady-state lateral tire forces are in opposite directions, and thus apply steering torques of opposite sign with any caster offset. If a steered rear wheel has trail like a steered front wheel, then the transient lateral tire force associated with a steer-angle change from the straight-ahead position applies a restoring torque, just as in the FWS case. However, the resulting steady-state lateral tire force toward the center of the turning circle would tend to increase the steer angle, causing a divergent hands-off instability and immediate spinout (note again it is not correct to think of this as oversteer). Since centripetal force increases with vehicle speed for a given steer angle, the severity of the instability increases with vehicle speed.

To provide a restoring torque during cornering, the preferred rear steering geometry has a tire-road contact patch which leads ahead of the point where the steering axis intersects the road ["negative caster", ref 6], as shown in Figure 2, even though this is opposite to "trail" intuition and transient torques are destabilizing. With RWS "negative caster", there is an oscillation which is less undesirable than the divergence due to caster or trail in the usual FWS direction.

Hands-off steering oscillation at high speeds is a reality for both FWS and RWS, which can be understood by another look at Figure 2. Recall that high-speed tire-slip angles are greater than the steer angle. If the FWS steering mechanism is released, the steer angle will rapidly return to zero, but a significant fraction of the front tire slip angle will remain, along with its

associated lateral tire force. Essentially, the vehicle is still in a left turn, and the remaining fraction of lateral tire force causes steer-angle overshoot to put the vehicle in a right turn. Several cycles may persist, but the oscillation is usually stable (it damps out) in the FWS case [9].

Now consider the RWS diagram in Figure 2. If the steering mechanism is released, the rear steer angle will return to the straight-ahead position, as desired. Unfortunately, the rear-tire-slip angle increases as this happens, resulting in an increasing lateral tire force for an overshoot torque greater than the steady-state restoring torque. The result is that RWS vehicles have an oscillation of increasing magnitude in the hands-off condition. To mitigate this instability, the caster offset distance should be small, as shown 50 years ago in Buckminster Fuller's patent drawing of the Dymaxion Car [3]. In 1983, the author showed by eigenvalue analysis that a large amount of steering damping can actually stabilize the oscillation [11, 12]. The IHPVA RWS speed record is over 22 m/sec (50 mph), set by Eric Edwards' Pegasus which incorporated the preferred RWS geometry with damping [2]. An active controller could stabilize the oscillation better than a damper, using relatively little power since the RWS destabilizing torques are transient with the preferred steering geometry [15].

There can be other stabilizing influences, such as a tilted steering axis which lifts the vehicle upon steering, to provide a restoring torque. With two steered rear wheels, steering-axis inclination in the transverse plane can be used to achieve this without losing symmetry. One report indicates RWS success with this concept [8, see also 7 and 18]. There is also the possibility of having limited front steering for high-speed stability, with RWS for tight cornering at low speed [13].

4. Person steering

The technical literature on driver steering control of automobiles typically considers that drivers adjust the steering-wheel position to obtain the desired path of motion on the roadway [4]. Newton's laws state that a force must be applied to move something, so the assumption that riders can directly control the angle of handlebars is therefore an approximation. In reality, forces must be applied to the handlebars or steering wheel, which translates to steering torque. The steering torque applied by the person is added to the caster-offset torque, steering-damping torque, etc., to determine the true response

of a vehicle. Surprisingly, there is a lack of technical literature that treats human steering as torque application. It seems likely that riders apply handlebar forces in order to obtain the desired steer angle, which is easy to do if steer angle and steering torque are in phase, as during typical FWS vehicle operation. Destabilizing, unsteady, unexpected torques require the rider's control torque vs. time to be more complicated to obtain the desired steer angle, i.e. steering is more difficult. Thus, it is desirable to have good "hands-off" stability, even if the person never releases the steering mechanism.

At the eighth IHPSC in 1982, the Red Shift II was run with "positive trail" RWS. After a small disturbance, the rider had to apply restoring steering torque to prevent the divergent instability. The unfortunate result was rider-induced overshoot in the opposite direction and a few cycles of rapidly growing (rider-in-the-loop) oscillation before the vehicle rolled. Top speed recorded was 17 m/sec (38 mph) [1, 5]. Also at the 1982 IHPSC, Karl Payne's vehicle number 37 with a multi-link RWS mechanism had its (virtual) steering axis aft of the hub, i.e. the preferred geometry. Co-builder Shawn Latham reported to the author that the vehicle would oscillate by itself, but this effect was mitigated by mounting the wheel further aft (reducing the offset distance as recommended above).

5. RWS two-wheelers

RWS bicycles are extremely difficult to ride, because of a problem in addition to the phenomena described above. Two-wheelers must be kept upright during straight riding, which means the center of gravity must be directly above the imaginary balance line connecting the two tire-road contact points. Balancing is nominally controlled by steering to keep the balance line under the center of gravity. With FWS, this results in slight leftward cornering if the bicycle had been leaning too much to the left, which is a stable equilibrium. If a RWS bicycle being ridden straight leans a little to the left, the rear wheel must be steered to the left to move the balance line under the center of gravity. However, this results in a right-turning condition, which tends to make the bicycle lean further to the left, a divergent instability.

The above analysis of balancing assumes the rider is rigid relative to the bicycle. However, lateral motion of the rider's torso to shift the center of gravity is an additional control input, which makes it

possible to balance an RWS bicycle. The author built a RWS recumbent bicycle in 1983, and could never ride it, but later observed a person riding an upright RWS bicycle. It has been reported that a recumbent RWS bicycle has been ridden at MIT [17].

Craig Cornelius has recently published a fascinating article on rear-steered recumbent bicycles (RSRBs) in the spring 1990 issue of *Human Power*. The effect of his very long trail design may be to make the dynamic behavior similar to that of front-steered bicycles.

Conclusion

Numerous RWS HPVs have appeared in IHPVA competition over the years. RWS will continue to be attractive to those seeking to optimize vehicle packaging, e.g. front wheel drive permits a short chain, and two nonsteered front wheels fit within a narrow fairing having small wheel openings. Acceptable stability for RWS HPVs has been achieved, but hands-off stability as good as with FWS may require active control. This would need a power source, so it may not be applicable to HPVs. Finally, the technical literature has ignored secondary stability-enhancing factors such as steering-axis tilt and variation of caster offset distance with steer angle, so it would be premature to conclude that the best passive steering mechanism for RWS HPVs has already been built.

John C. Whitehead
JCW Engineering
3322 Biscayne
Davis, CA 95616 USA

John Whitehead is a mechanical engineer and has been an IHPVA member with an interest in rear-wheel-steering since 1982. He has built and tested several RWS vehicles, ranging from tabletop models to HPVs, to an instrumented car-sized experimental vehicle for his PhD research. More recently, he has proposed an active steering stabilizer to help automobile drivers maintain control during emergency maneuvers, which would also stabilize RWS vehicles.

References

1. Champlin, C., *The Eighth IHPSC*, Human Power, 2/2, p. 5, Spring 1983.
2. Edwards, E., *Rear Wheel Steering*, Second IHPVA Scientific Symposium Proceedings, p. 140, A.V. Abbott, ed., 1983. Experience with RWS Pegasus HPV (see also various refs to Pegasus in HP News, 1/5, Aug 1983 p.1, 1/6, Nov 1983 p.2.).

3. Fuller, R.B., *Motor Vehicle*, U.S. Patent no. 2,101,057, 1937.

4. McRuer, D., et al, *Measurement of Driver-Vehicle Multiloop Response Properties with a Single Disturbance Input*, IEEE Trans. on Systems, Man and Cybernetics SMC-5, 490-497, 1975.

5. Milkie, T., *A Note on Rear Wheel Steering*, HPV News 1/11, June 1984. Excellent builder/rider account, but some technical inaccuracy.

6. Mitschke, M., *Comparison of the Stability of Front Wheel and Rear Wheel Steered Motor Vehicles*, Proceedings of the 6th Symposium on the Dynamics of Vehicles, International Association of Vehicle System Dynamics, Berlin, pp 316-322, 1979.

7. Perkins, R., *Tricycles: Front and Rear Steered*, HPV News 2/3, Oct 1984. Thebis has two steered rear wheels with large camber angles (also June 85 issue p. 6, August 87 p. 8, Oct 88 p. 11).

8. Riley, J., *Just Recumbents*, HPV News 4/6 p. 3, Jan 1988. Vacuum Velocipede has two steered rear wheels with steering axis inclination, wheel camber, and damper evident in photograph.

9. Segel, L., *On the Lateral Stability and Control of the Automobile as Influenced by the Dynamics of the Steering System*, ASME Journal of Engineering for Industry, August 1966.

10. Strandberg, L., *On Driving Safety and Dynamic Characteristics of Rear Wheel Steered Vehicles*, Proceedings of the 9th Symposium on the Dynamics of Vehicles, International Association of Vehicle System Dynamics, 1985.

11. Whitehead, J.C., *Rear Steering of Road Vehicles: An Analysis of Yaw Stability*, Masters Thesis, University of California at Davis, 1983.

12. Whitehead, *Yaw Stability of Rear Steered Human Powered Vehicles*, Second IHPVA Scientific Symposium Proceedings, p. 136, A.V. Abbott, ed., 1983.

13. Whitehead and D.L. Margolis, *Three Steered Wheels for Ultimate Economy with Good Handling*, Society of Automotive Engineers Trans. 861132, 1986.

14. Whitehead, *Response, Stability, and Driver Control of a Rear Wheel Steering Vehicle*, PhD Thesis, University of California at Davis, 1987.

15. Whitehead, *Stabilizing Steering Weave with Active Torque Versus Semi-Active Damping*, SAE 891981, 1989.

16. Whitehead, *Rear Wheel Steering Dynamics Compared to Front Steering*, ASME Journal of Dynamic Systems, Measurement and Control, March 1990.

17. Whitt, F.R., and D.G. Wilson, *Bicycling Science*, p. 233, MIT Press, 1982.

18. (author unknown), *Astar—Innovative Steering Design*, HPV News 2/9 p. 5, June 1985. ASTAR has two rear wheels which steer and lean. □

How to make a wooden propeller

(continued from page 1)

propellers of similar characteristics and other dimensions.

As is the case with most propellers we will use a helicoidal surface for the "face", or after side, of the propeller blade. This helicoidal surface is generated when a straight line (the "element") revolves with uniform speed about an axis through one of its ends and at the same time moves with uniform speed parallel to itself along the axis. Any point on the straight line then generates a curve in space called a helix, which lies on the surface of a co-axial right circular cylinder. This distance along the element between the axis and the given point is the radius, r , and the distance this point moves parallel to the axis during one revolution (360°) is the pitch, H . The successive positions of the element constitute the helicoidal surface.

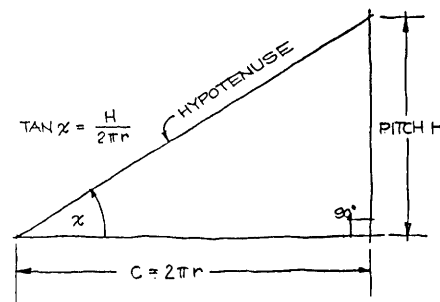

Figure 2. Pitch angle α @ radius r

If we unwrap one of these co-axial right circular cylinders and lay it out flat, the helix it contains will appear as the hypotenuse of a right triangle whose base is the circumference C of that cylinder ($C = 2\pi r$) and whose altitude is the pitch H . The angle between the hypotenuse and the base is the pitch angle α , whose tangent is $H/(2\pi r)$.

Assuming a maximum blade width of 4 inches (102 mm) at a radius of 5 inches (127 mm)[2], a 2-1/2-inch- (63.5 mm)-diameter hub, blade thickness of 3/8

inches (9.5 mm), 5/8 inch (16 mm), and 3/4 inch (18 mm) at tip, maximum width, and hub, respectively, and 1/2 inch (12.7 mm) plywood, we can start to determine the pattern for the blade laminations as follows.

First, calculate the pitch angles at the radii of the hub, of the point of maximum blade width, and of the blade tip. These are

$$\tan \alpha (\text{hub}) = 24 / (2\pi \cdot 1.25) = 3.0564 \times (\text{hub}) = 72^\circ$$

$$\tan \alpha (\text{max}) = 24 / (2\pi \cdot 5) = 0.7641 \times (\text{max}) = 37.5^\circ$$

$$\tan \alpha (\text{tip}) = 24 / (2\pi \cdot 8) = 0.4776 \times (\text{tip}) = 25.5^\circ$$

Next, draw a series of seven straight horizontal lines 20 inches (500-mm) long on a sheet of drawing paper, exactly 1/2-inch (12.7-mm) apart. About two inches (50 mm) from the left on the bottom line locate three points about five inches (130 mm) apart. These points represent the straight-line element which will be the trailing (after) edge of the propeller blade. At the left element-point, draw a line at the hub pitch angle of 72° ; at the center point draw a line at the maximum blade-width radius pitch angle of 37.5° ; and at the right draw a line at the tip pitch angle of 25.5° . These inclined lines are the hypotenuses representing the blade face at each radius.

Above and to the left of the hypotenuse for the pitch angle at maximum blade-width, lay out maximum blade-width of 4 inches (102 mm), and the blade thickness of 5/8 inch (15 mm), as shown in the figure. The enclosing rectangle will then determine the required number and required width of the plywood laminations on each side of the trailing-edge element at this radius. A similar procedure, for the same number of laminations and specified blade thicknesses, is followed at the hub and tip to determine the plywood dimensions on each side of the element at those radii.

We are now ready to make the pattern for the blade laminations. On a sheet of tough, thin cardboard, draw three concentric circles at the hub radius of 1-1/4 inches (31.75 mm), maximum blade-width radius of 5 inches (127 mm), and tip radius of 8 inches (203 mm). Then draw three radii at 120 degrees, which will be the trailing-edge elements of the propeller blades. Taking each radius in turn, lay out the lamination widths we have just found, at the appropriate radial distances from the center, along the arcs. To be precise, these distances should be laid out along the arcs, but measuring them as chord dimensions here will provide a little extra margin for the plywood. Connect these points with smooth, fair lines, and we then have the pattern for the laminations. Carefully cut

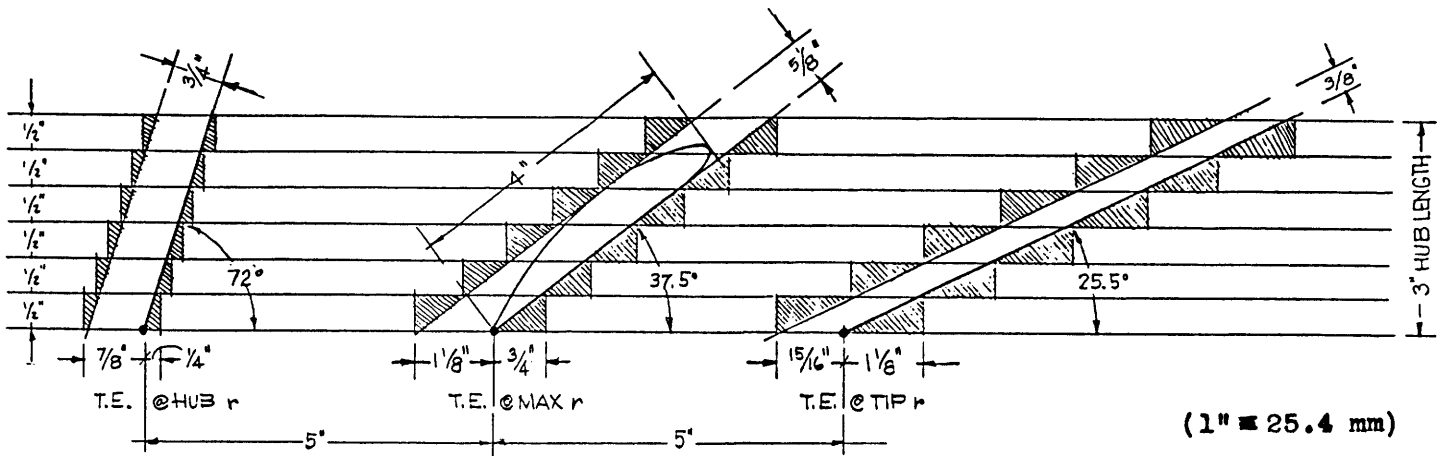

Figure 3. Lamination sizing

this out of the cardboard, "saving the line", and check for interblade uniformity by tracing each blade pattern one on top of the other on a piece of paper to see if they coincide.

Use this pattern to lay out the required number of laminations on a sheet of 1/2-inch (12.7 mm) marine-grade plywood ("marine" because this grade is less likely to have internal voids than is common plywood). Be sure to carefully locate the center point in each case. The patterns can be interfingered on the sheet to minimize waste. Use a sabre or band saw to carefully cut out the laminations—again saving the line—and then carefully drill each for a 3/4-inch- (19-mm)-diameter propeller shaft.

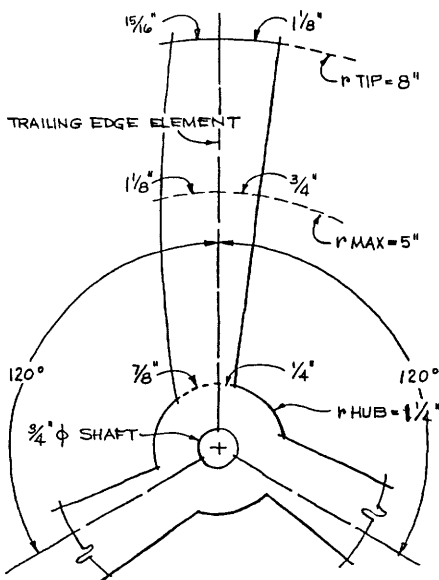

Figure 4. Lamination pattern

The next step is to make the assembly platform, exactly 16 inches (406.4 mm) square. The same 1/2 inch (12.7 mm) plywood may be used, solidly mounted on a

1-1/2-inch- (38-mm)-thick frame on the underside, and with a block 1-1/2-inch (38-mm) thick by 4-inch (100-mm) square underneath in the center. This should be drilled carefully for a 3/4-inch (19-mm) dowel, perpendicular to the platform and extending 6 inches (150 mm) above it. Taking each lamination in turn, place it over the dowel on the platform and, using its outer edge as a guide, sand off the tip of each blade to a uniform 8-inch (203-mm) radius.

Before we assemble the laminations we must prepare three jigs to insure their proper positioning while being epoxied together. These jigs are made of thin, stiff cardboard (manila file folders will do). Each consists of a strip of width of the same number of 1/2-inch (12.7 mm) laminations as the propeller itself, and cut to a step-like profile identical with that of the lamination-blanks at the blade tips.

The next step is to make a trial assembly of the laminations on the platform. Position the helicoidal-surface up on the dowel, with each blade having the trailing-edge element at the left, and the laminations rotated clockwise from the top down to the platform in accordance with the tip-jig used as a guide on the outer surface of their tips.

When all is in order, remove them from the platform, rub the dowel thoroughly with some wax and cover the platform with a sheet of waxed paper cut to fit over the dowel. Now start the epoxied assembly, being sure each successive surface is completely and uniformly coated, and carefully positioned with the aid of the jigs pinned around the outer surface. Place the same amount of weights uniformly over each blade-stack while curing.

A wood rasp is the best tool for the initial removal of the corners of the laminations down to the helicoidal surface

of the face of the blades, followed by progressively finer wood files. In doing this, note that all the plywood laminations should be kept as straight radial lines. Do not deal with the other side of the blades at this time. With the helicoidal face of the blades thus roughed out, we can now turn our attention to the outline shape of the blades themselves.

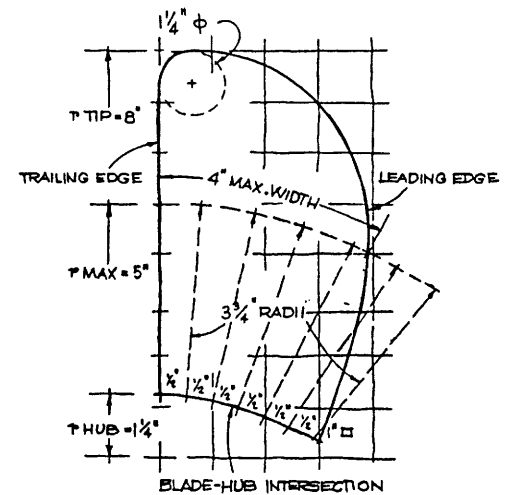

Figure 5. Blade pattern

To make a pattern for the blade profile we will fit a piece of thin, tough cardboard to the present fan-shaped surface of the blade face. Since the helicoidal blade surface is three-dimensional and the cardboard is two-dimensional, it will not lie flat, but the difference is not too great and the approximation is reasonable. Align a straight edge of the cardboard with the radial line of the trailing edge, and by cut-and-try, fit the inner edge of the cardboard as close as possible to the curve where the blade surface meets the hub cylinder. (Note that the length of this line equals the length of the hypotenuse at $x(\text{hub}) = 72^\circ$: in our case, 3-1/8 inches (79.4 mm). When this is done, lay the

cardboard flat and spot a series of points about 1/2-inch (12.7 mm) apart along this line. Using them as centers, and a compass setting of 3-3/4 inches (95.25 mm), the radius at maximum blade curvature, 5 inches; minus hub radius, 1-1/4 inch, draw a series of arcs on the pattern. A smooth curve across their tops will be the intersection of the cylinder of 5-inch (127-mm) radius with the helicoidal surface. We must next lay off the required blade-width along this line.

To do this take a strip of paper and lay out the required blade width of 4 inches (102 mm) along one edge. Then place this edge outside, on the convex side of the above curve, with one endpoint at the straight trailing edge and tangent to the curve and, in essence, "roll" this edge along the curve. This is done by using a sharp pencil-point pressed close to the edge of the strip as a pivot, and rotating the strip just a bit to a new point of tangency along the curve. Holding the strip in this new position, the pencil point is shifted a bit further along the strip, and the strip again rotated to a new point of tangency. This process is called "ticking off" the length along the curve, and obviously the closer together the successive pivot points, the more accurate the transfer of the dimension.

Turning our attention next to the tip of the blade, draw in a circle of 1-1/4-inch (31.75-mm) diameter tangent to the straight-line trailing edge and tangent to a line perpendicular to it at its end. A fair curve drawn through the end of the hub intersection, the point of maximum blade width, and tangent to the last-mentioned circle will be the profile of the leading edge of the blade. This pattern is then cut out and used to trace the outline on each blade, being careful to keep the straight edge in line with the trailing edge, and the hub cut-out snug against the hub. Use a coping saw to trim the wood to this profile.

At this point, we can turn the propeller over and rasp off just the corners of the laminations on the back surface of the blades. Before we can proceed with the final shaping of the blade sections, we need to make one more template: that of the blade-section at maximum blade width.

This will be an airfoil shape, whose heights ("ordinates") above the straight-line face of the blade, at ten equally-spaced stations along the blade width or "chord", are shown first as percentages of the maximum blade thickness at this radius (in our case, 5/8 inch (16 mm) and 5 inches (127

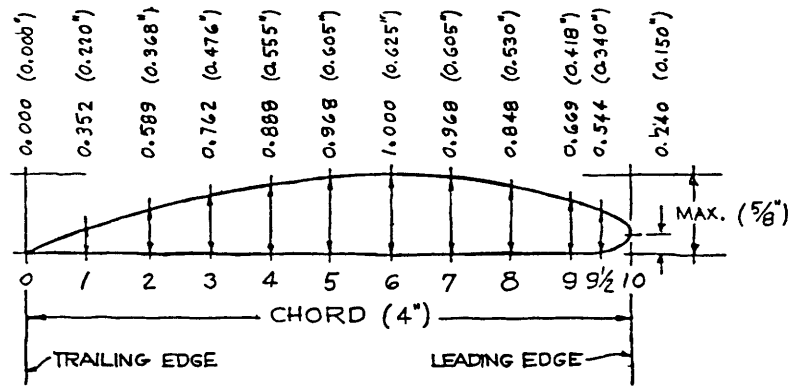

Figure 6. Blade section @ max. width

mm), respectively, for a chord length of 4 inches (162 mm)], and then as inches for our example.

Thus, the next task is to carefully lay out this blade-section profile on a sheet of tough, thin cardboard and cut it to shape. The cardboard is then trimmed to the form shown in the figure and mounted perpendicularly around the edge of a 10-inch-(254-mm-) diameter disk of 1/2-inch (12.7-mm) plywood, which fits over the 3/4-inch (19-mm) dowel on the assembly platform.

With the propeller helicoidal surface face down on the platform, use this jig to check your profiling of the back of each blade at the 5-inch (127-mm) radius. When this is done, rasp and file off the rest of the blade surfaces, using the radial lines of the plywood laminations as guides to produce a smooth, fair surface based on this key section. The tip of the blades should be trimmed to about a 1/8-inch (3-mm) radius. The final step is to form the curved part of the blade face at the leading edge, and then the surface of the entire propeller is smoothed off with progressively finer

grades of sandpaper.

The last step is to paint the propeller with two coats of epoxy, sanding after each to end with a very smooth finish. Be sure to epoxy the inside of the bore for the propeller shaft, too. The propeller can be secured to the propeller shaft by means of a roll pin through the hub and shaft. If desired, a tail-cone of laminated plywood can be epoxied behind the hub.

If the propeller becomes damaged in use, it may be easily repaired by cutting out the affected area to reach sound material, and filling in the void to the original profile and contour with a stiff paste of epoxy and fine sawdust. A subsequent filing and sanding to the original form completes the repair.

Notes

1. According to DeLong, an "average" person can sustain an output of about 0.225 hp (170 watts) over a one-hour period, with near maximum efficiency at a pedal speed of 60 rpm. Assuming a mechanical efficiency of 0.9 and a gear ratio of 1:4, this results in 0.2 hp (150 watts) and 240 rpm at the propeller.

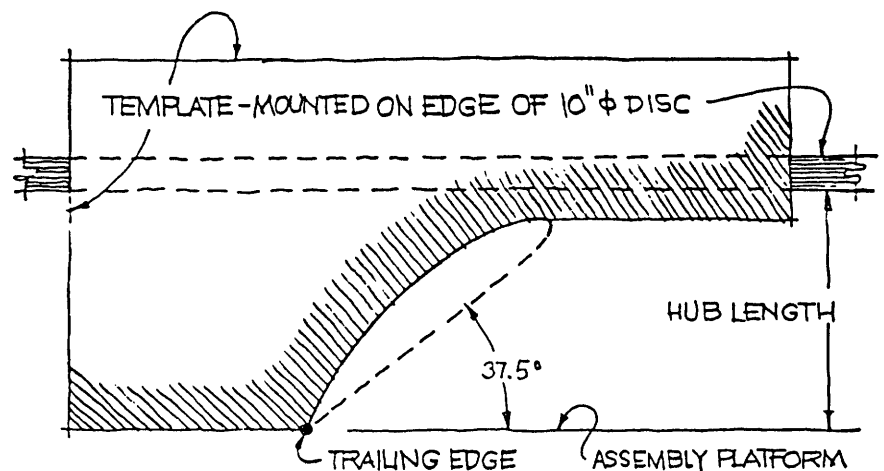

Figure 7. Blade section jig

The Troost B.3.35 model is a high-efficiency pattern with good acceleration characteristics, suitable for an all-weather cruising boat. As embodied here it differs from the original with the elimination of the 15-degree-aft blade rake, and a slightly thicker blade section.

See: Fred DeLong, *DeLong's Guide to Bicycles and Bicycling*, Radnor, PA: Chilton Book Co., 1978; and L. Troost, "Open Water Test Series with Modern Propeller Forms", Newcastle, G.B.: Transactions of the North-East Coast Institution of Naval Architects, 1950-51. For an accessible introduction to the details of empirical propeller design, see Dave Gerr, *Propeller Handbook*, Camden, ME, USA: Internat'l Marine Publishing Co., 1989.

2. To give a developed-area ratio of 0.35. The developed-area ratio (DAR) is the true area of the blade (not the projected area) times the number of blades; divided by the disc area of the propeller, or R^2 , where R is the radius of the propeller.

Philip Thiel
4720 7th Ave., NE
Seattle, WA 98105 USA

Philip Thiel has taught naval architecture at M.I.T., and architecture at Berkeley and the University of Washington in Seattle. His interest is in facilitating the do-it-yourself construction of pedal-powered cruising craft.

Reviews

(continued from page 4)

chain friction, windy hills, wheel drag and the like. There are also articles on cycling instrumentation, Shimano pedaling dynamics, cycling-shoe biomechanics, and the Huffy composite Triton.

Cycling Science is a very valuable journal, founded and edited by IHPVA's co-founder Chet Kyle, and a year's subscription and associate membership in the Cycling Research Association cost \$19.97. (P.O. Box 1510, Mount Shasta, CA 96067, USA).

HPV Times

The first issue of "the Aussie newsletter for exploring the human limits to pedal power" is, as would be expected, breezy and entertaining as well as informative. It has started fairly small, as would be expected, with two main articles ("Practical vehicles", by editor Wayne Kotzur, and "Building a world-beater" by the UK Bluebell team).

Four issues a year cost \$10.00 (I don't know how that translates to other than Australian currency and how overseas mail costs would add to it). Wayne Kotzur, 26 Mills St, Hackett, Australia ACT 2602.

—Dave Wilson

Bicycle fairings and efficiency

by Dave Kehoe

Do bicycle fairings really work? Are they worth buying?

A fairing is a device that redirects air flow around a cyclist. Fairings offer these advantages:

- reduced aerodynamic drag, making the bicycle faster
- keeping the cyclist warmer in the winter
- preventing the cyclist's eyes from tearing on fast descents
- providing a surface for reflective tape, improving visibility at night
- deflection of branches and other hazards from the cyclist's face
- slight rain protection

Because most fairings do the latter items equally well, I compared different fairings' effects on my speed.

Context

IHPVA members are familiar with the speed records of fairing-equipped bicycles. The world record for unfaired, upright bicycles is about 43mph (19m/s); fairing-equipped recumbent bicycles hold records above 65mph (29m/s). The record for upright, faired bicycles is 51mph (23m/s), held by a Moulton with a fully-enclosed Zzipper fairing.

Several hypotheses can be drawn from these records. First, the advantage of a fully-enclosed fairing (8mph, 3.5m/s) is less than the advantage of a recumbent (14mph, 6m/s). Second, because wind drag is greater at higher speeds, the advantage of a fully-enclosed fairing at normal riding speeds (20-25mph, 9-11m/s) would be considerably less than 8mph. Lastly, the advantage of a partial fairing would be even less, probably less than 1mph at 20-25mph. Perhaps IHPVA members have specific data to check these hypotheses.

Fully-enclosed fairings are heavy, hard to handle in windy conditions, and the cyclist inside can overheat. I doubt any of these will be seen on the street.

Partial fairings are lightweight, inexpensive, and don't adversely affect handling or cooling. Partial fairings have the greatest potential for boosting the speed of a street cyclist, and at least half a dozen are commercially available. I tested these.

Test methodology

In the absence of a wind tunnel, aerodynamics testing can be done by coasting down a hill. Three measurements can be taken: time over a distance, with a stopwatch; distance covered before coasting to a stop; or maximum speed.

Time is the poorest choice, because most time is spent coasting slowly at the top of the hill while gathering speed. A large difference in terminal velocity would appear only very small on a stopwatch.

Distance covered is the most sensitive, but you need a hill followed by a long, flat road without stop signs. I couldn't find any in Portland.

I chose to measure maximum speed, which is a function on my Cateye Micro speedometer. I then chose the steepest hill in Portland (SW 48th at Taylor's Ferry). The results (below) showed that my Zzipper fairing increased my speed from 43.5mph to 47mph (19 to 21m/s). But the Cateye Micro measures maximum speed in whole mph, and the other fairings' effects, if any, were one mph or less, falling within the margin of error.

Also, after 15 tests I was really tired of climbing the hill. I decided for my next tests to use a more sensitive speedometer and a smaller hill. I wanted to do tests at the speeds I normally ride, 20-25mph, to see if fairings help in everyday use.

Cateye's old Solar speedometer measures maximum speed in tenths of a mph. I then doubled the wheel size input. In other words, I was supposed to enter 1070 for my wheel size, but I entered 2140. Thus, at 25mph, the speedometer shows 50mph, and maximum speed is recorded in twentieths of a mph (0.05mph).

Next, I found a smaller hill (SE Woodstock near Reed College), and on a windy January afternoon I did 15 more tests. But the results varied too much, and the control was at 30mph (13m/s), so I looked for a smaller hill.

I found a small hill a few blocks from my house (SE 31st and Franklin), and did 225 coastdowns over five weekend mornings. There was practically no wind early in the morning. Maximum speeds were 21-22mph (9m/s), my normal riding speed, and consecutive runs were very close in speed—often three or four consecutive runs would show exactly the same speed, say, 21.85mph. The hill was so

small I could sprint back up it in less than a minute.

Variables

The first variable to consider was my position. Could an unconscious change of position affect the results? I decided to test how a conscious change in position affected results. Sitting as high as I could or crouching low on the stem only changed my speed 0.33mph to 0.5mph (0.15 to .22m/s) at 21mph, so slight, unconscious differences would have had minimal effect.

I used two positions on my bike for these tests. In "drop position" my hands were on the lower part of the bars, touching the brake levers, but my arms were straight and my elbows locked. This is similar to the position I usually ride in, in which I can produce maximum power. My handlebars are 1.5 inches below my seat, and my head and shoulders were always above the fairings.

I also did tests in the "full tuck" position: crouched as low as I could still pedal, my chin almost on my speedometers. This is how I go down hills, and I have to look through the fairing.

Slight, imperceptible winds would certainly affect results. To compensate, I ran each test at least eight times. I then averaged the results and calculated the standard deviation of the mean. Finally I added the standard deviation of the mean of the test runs to the standard deviation of the mean of the control runs.

National Cycle AeroSport

This is the smallest and lightest of the handlebar fairings. With a 0.79mph (0.35m/s) increase in speed, it's also the most effective in the drop position. It's effective because it can be adjusted up or down, close to or away from the cyclist. Fairings should be as close as possible to the cyclist's chest, while being far enough away to crouch behind for maximum speed down hills. After eighteen months of daily commuting with the AeroSport, I've found that crosswinds have virtually no effect on handling.

At \$65, it's the least expensive fairing available. It's also very attractive-looking—one motorcyclist commented it looked like a Ninja fairing.

Zzip Designs Zipper

The Zipper is the most effective fairing for descending steep hills in a full tuck—a 0.9mph increase @32mph, and a 3.5mph boost @43.5mph (0.4m/s @14m/s, 1.5m/s @19m/s). It feels like a little

turbocharger.

But the Zipper is less effective than the AeroSport in the drop position, at slower speeds (+0.46mph @21mph; 0.2m/s @9m/s).

Why is one fairing better in one position and another better in another position? The Zipper's shape conforms to a cyclist's frontal shape in a full tuck, and the AeroSport conforms to a cyclist's frontal shape when sitting up. The AeroSport can be moved closer to your body; the Zipper is non-adjustable. To move the Zipper closer to you, you have to buy a shorter stem (using a 3cm shorter stem noticeably improved performance). Even in its farthest position, the AeroSport is closer than the Zipper.

The Zipper is lightweight (15 ounces) and unobtrusive. On my commute to work, I have several steep hills, with speed limits up to 40mph (18m/s). With the Zipper I can climb the hills on the shoulder, and then "take the lane" on the descent, tucking under it and riding with the traffic at 40mph.

In cold weather, the Zipper covers your hands (unlike the AeroSport), so your hands stay warm (all the fairings make a big difference in keeping your chest warm in the winter).

I've never overheated in the summer when using my Zipper, and I've used it in 110° weather. If I ride on top of the bars, I'm above the fairing, and as long as I'm moving there's enough wind to keep me cool. When hillclimbing out of the saddle, I'm completely above the fairing, so it doesn't affect me.

Which is better, the AeroSport or the Zipper? After 18 months with the former and 7 years with the latter, they're very close. The Zipper is slightly better if you have a lot of fast descents, and the AeroSport is slightly better for riding on the flats.

I also tested an experimental Zipper with a piece of hot pink Lycra that wraps around my butt. Real eye-catching in traffic, but I detected no advantage with the Lycra at 22mph. It seemed real fast when descending hills over 40mph, but I didn't test it at these speeds.

National Cycle AeroCarrier

This fairing doubles as a handlebar pack—you can carry about five pounds of groceries or gear in it. But the fairing is heavy, and when it's loaded the bike handles badly. I prefer to use Tailwind front panniers—I can carry about four times as much gear, and the bike handles great. With an AeroSport and Tailwinds,

my cruising speed is the same as with the AeroCarrier.

The AeroCarrier is also black, so you can't see through it or crouch behind it. Downhill speeds are slower than tucking under the Zipper or AeroSport. The AeroCarrier is also less attractive-looking. It includes a space for a headlight, but neither a Bicycle Lighting Systems 4.5" sealed beam, a Union halogen, nor a Soubitez headlight fit. At \$100, I wouldn't recommend it.

Uni-BMX UniDisks

These are the only fairings allowed by the USCF. They're spoke covers, and look just like disk wheels, except that they cost \$35 instead of \$800. They're a pain to install, and you have to take one side off to pump up the tire, and both sides off to true the wheel. They get kind of soggy in the rain. Their increase in speed was small, at all speeds, and was always within the margin of error. Crosswinds aren't really a problem, but I wouldn't recommend buying these.

However, many of you are thinking of buying disk wheels. Is it worth spending another \$765 for the disk? The data I've seen indicates that a rear disk wheel will increase speed 0.25mph (0.11m/s) at 25mph (11m/s). I feel confident in saying that the UniDisks will do almost the same thing. They're lighter than disk wheels, don't affect handling, and don't give a harsh ride. If I were racing, I'd buy UniDisks before disk wheels.

UniDisks also look really neat. I bought the "LED" black and white pattern, and I got a lot of comments, especially from kids. In combination with my tailcone, I heard "Wow! Look at that!" a lot. Nobody has ever said that about my Zipper.

Tailcone and small fairings

I fabricated an 18-inch tailcone out of styrofoam and bolted it to the back of my saddle. I also put a little piece of balsa behind my head tube, and a larger piece between the seat tube and rear tire. These had minimal effects.

In theory, the trailing edge is more important than the leading edge. Tear-drops are blunt in front, but taper in back, controlling turbulence.

But a front fairing helps to make air flow smoothly around the cyclist, producing less turbulence. Without a front fairing, turbulence is generated, and a tailcone can't control turbulence that's already been created.

I suspect the tailcone had no effect

because it was entirely within my slipstream. If a cyclist riding five or six feet behind me is within my draft, an 18-inch tailcone won't do anything. I'd probably need a longer tailcone to see a difference.

My tailcone is very light and doesn't catch in crosswinds or affect handling. A tailcone could be made to hold tools and a spare tire, or as a sleeping-bag stuff sack for tourists.

Tailwind front panniers

These had very little effect at normal riding speeds. They do slow me down at very high speeds, though. The Tailwinds are teardrop-shaped, with no outside pockets. They're not made anymore. Perhaps I'll test other panniers sometime in the future and see how much effect panniers have on speed. Lightning makes low-drag panniers for their recumbent. (Lightning also makes fiberglass wheel covers that should be faster than the UniDisks, though they're heavier (360grams) and more expensive (\$85).)

Tests on three different days showed the same results, which reflected well on my methodologies.

Loading 16 pounds of water bottles in the panniers increased my speed slightly, but not much.

Clothing

Almost all the tests were done wearing Nike's Lycra/nylon cycling jacket. All the clothing was very close in speed. Run #4 between my yellow North Face GoreTex jacket and the Nike jacket alternated runs wearing each jacket, and is the most accurate, showing that the Nike jacket is probably 0.1mph (0.04m/s) faster than the North Face jacket.

A Lycra jersey (without a jacket) and a leather jacket showed small but insignificant advantages over the Nike jacket.

Higher speeds

The August and January tests confirmed the results of the February tests, but made a very important point: fairings become more important the faster you go. At 21mph (9m/s), the Zzipper's effect is barely noticeable, just 2%. But at 43.5mph (19m/s), it boosted speed 3.5mph (1.6m/s), or 8%. Pedaling with the Zzipper increased my speed to 50mph (22m/s), so, in other words, a cyclist coasting with a Zzipper would go as fast as a cyclist pedaling without one, on very steep hills.

This explains why fairings are important to cyclists who want to break speed records, and unimportant to everyone else. The vast majority of cyclists

ride 10-15mph (4-7m/s). Wind drag isn't the biggest component of energy loss at those speeds. Rolling resistance of tires uses more energy, as does acceleration and hill climbing. Fairings are just not going to do anything for 99% of the cyclists on the road—lower rolling resistance tires and lighter bikes, especially lighter wheels, would be more effective.

The envelope, please

Should you buy a fairing? The AeroSport and the Zzipper are worth buying for a lot of reasons. \$75 won't buy an Italian derailleur anymore, so a fairing may be the most cost-effective upgrade you can make on your bike.

The future

But will we someday be able to zip down the freeway, passing cars? Better fairings could be designed for riding in a certain position. But designing a fairing that works well in several riding positions is difficult, and I doubt we'll see much improvement in future fairings. Bigger fairings have to be farther away, so have no inherent advantage over small fairings. Perhaps the right tailcone could boost the effectiveness of a front fairing.

There are several barriers to sales of fairings. Cyclists often judge a bicycle's speed by the quickness of its steering, and fairings slow steering. Additionally, few people understand what these "wind-shields" do (keep the bugs off?)—their purpose is not obvious—and knowledge of the science of cycling is poor even among serious cyclists. Lastly, fairings are only effective above 25mph, and few cyclists ride that fast.

To successfully market a fairing, it will have to look fast—in other words, fulfill a cosmetic function as well as a streamlining function. Engineers may cringe at the word "cosmetic," but if a manufacturer were to combine wheel covers, a tailcone, a Bell Stratos helmet, the AeroSport "Ninja fairing," streamlined front panniers, head and seat tube fairings,

and a good paint job they'd never be able to keep up with demand. Granted, only the front fairing will actually be doing anything, but the consumers would never know.

Resources

National Cycle, Inc.
2200 Maywood Drive
P.O. Box 158
Maywood, IL 60153-0158
(312) 343-0400

Lightning Cycle Dynamics
1500 E. Chestnut Ct. Suite #
Lompoc, CA 93436
(805) 736-0700

Zzip Designs
Davenport, CA 95017-0014
(408) 425-8650

Uni-BMX
8025 S.W. 185th
Aloha, OR 97007
(503) 649-7922

Dave Kehoe
2808 SE 26th
Portland, OR 97202



Correction

A typographical error crept into page 7 of Theo Schmidt's article in HP 8/1. The second sentence following the heading "Moving-skin boat" should read, "There is a minimum speed below which water surface waves cannot be generated (-0.23 m/s), and it follows that, if a hull is so slender that lateral and vertical velocity components of the hull entering and leaving the water are below this figure, no waves will be generated (on smooth water), although in practice there will always be some disturbance giving rise to some waves."



Fairing/component	Speed difference	Sum of std. dev. of the means
<i>February 1989: drop position; 21mph (9.39m/s); Cateye Solar — 1/20mph (1/40m/s) increments</i>		
dropped position	control	
upright position	-0.36mph (0.16m/s)	±0.19mph (0.08m/s)
full tuck position	+0.50mph (0.22m/s)	±0.23mph (0.10m/s)
National Cycle AeroSport	+0.79mph (0.35m/s)	±0.36mph (0.16m/s)
National Cycle AeroCarrier	+0.58mph (0.26m/s)	±0.46mph (0.21m/s)
Zzip Designs Zzipper	+0.46mph (0.21m/s)	±0.39mph (0.17m/s)
UniBMX UniDisks	+0.26mph (0.12m/s)	±0.29mph (0.13m/s)
tailcone (handmade)	+0.09mph (0.04m/s)	±0.29mph (0.13m/s)
little fairings (handmade)	+0.11mph (0.05m/s)	±0.30mph (0.13m/s)
Tailwind front panniers (1)	+0.04mph (0.02m/s)	±0.32mph (0.14m/s)
Tailwind front panniers (2)	+0.07mph (0.03m/s)	±0.18mph (0.08m/s)
Tailwind front panniers (3)	-0.12mph (0.05m/s)	±0.29mph (0.13m/s)
panniers loaded with 16 lbs.	+0.23mph (0.10m/s)	±0.33mph (0.15m/s)
Nike cycling jacket	control	
North Face GoreTex jacket (2)	+0.08mph (0.04m/s)	±0.53mph (0.24m/s)
North Face GoreTex jacket (3)	-0.26mph (0.12m/s)	±0.31mph (0.14m/s)
North Face GoreTex jacket (4)	-0.13mph (0.06m/s)	±0.48mph (0.21m/s)
Lycra jersey	+0.14mph (0.06m/s)	±0.50mph (0.22m/s)
leather jacket	+0.07mph (0.03m/s)	±0.63mph (0.28m/s)
tires at 120psi	control (Michelin Hi-Lite Road 700x23mm front, Specialized Touring II 700x28mm rear)	
tires at 60psi	-0.13mph (0.06m/s)	±.21mph (.002mph/psi) (.09m/s)
tires at 30psi	-0.16mph (0.07m/s)	±.21mph (.002mph/psi) (.09m/s)
204 coastdowns total		
<i>April 1989: Zzip Designs Zzipper, experimental model with Lycra attachment; 22mph (9.83m/s); Cateye Solar — 1/20mph increments</i>		
drop position	+0.30mph (0.13m/s)	±0.20mph (0.09m/s)
tucked position	+0.40mph (0.18m/s)	±0.29mph (0.13m/s)
16 coastdowns total		
<i>February 1989: 32mph (14m/s); Cateye Solar — 1/20mph increments;</i>		
full tuck position	control	
Zzipper, full tuck	+0.90mph (0.40m/s)	±0.25mph (0.11m/s)
AeroSport, full tuck	-0.17mph (0.08m/s)	±0.23mph (0.10m/s)
drop position, no fairing	-1.60mph (0.72m/s)	±0.45mph (0.20m/s)
drop position	control (31mph) (13.86m/s)	
Zzipper, drop position	+0.10mph (0.04m/s)	±0.80mph (0.36m/s)
Aerosport, drop position	+0.50mph (0.22m/s)	±0.66mph (0.30m/s)
21 coastdowns total		
<i>January 1989: drop position; 30mph (13m/s); 5-10mph crosswinds; Cateye Solar — 1/20mph increments;</i>		
National Cycle AeroSport	+0.85mph (0.38m/s)	±1.62mph (0.72m/s)
National Cycle AeroCarrier	+0.26mph (0.12m/s)	±1.41mph (0.63m/s)
Zzip Designs Zzipper	+0.10mph (0.04m/s)	±1.50mph (0.67m/s)
full tuck position	+2.03mph (0.91m/s)	±2.04mph (0.91m/s)
15 coastdowns total		
<i>August 1988: full tuck; 43.5mph (19m/s); Cateye Micro — whole mph increments only</i>		
Zzip Designs Zzipper	+3.5mph (1.6m/s)	±0.7mph (0.3m/s)
Uni-BMX UniDisks	+0.5mph (0.2m/s)	±1.4mph (0.6m/s)
tailcone (handmade)	+1.0mph (0.4m/s)	±0.7mph (0.3m/s)
little fairings (handmade)	+0.0mph	±0.7mph (0.3m/s)
Tailwind front panniers	-2.0mph (0.9m/s)	±0.7mph (0.3m/s)
15 coastdowns total		
mph = miles per hours; m/s = meters per second (mph x 0.447)		

The Seacycle story

by John Foley

The *Seacycle* originated from Portland graphic designer Robert Bailey's idea for a high-performance pedal-powered watercraft. Bailey commissioned John Foley and Terry Jones to design and build a pedal-powered catamaran. Foley and Jones were at the time engaged in designing and building recumbent bicycles. Jones, an industrial engineer with a mechanical-engineering degree from the University of Washington, brought to the task an extensive background of racing and building bicycles, as well as a lifelong interest in sailing.

Bailey's craft was a catamaran using 19-ft. (5.8-m) hulls, tubular aluminum framework and a drive system purchased from John Knapp. Knapp, as IHPVA members may well be aware, is the designer and builder of the *Sea Saber*, the craft that introduced many of us on the West Coast to high-performance pedal craft. The Knapp drive system consisted of a 1:4 gearbox, a drive shaft and a 17-in. (430-mm) two-bladed propeller. Total weight of the boat was 120 lbm (54.5 kg); steering was accomplished via two rudders mounted off the hulls' stern.

The craft participated in the events and demonstrations sponsored by the IHPVA at the 1986 Expo held at Vancouver, B.C. The boat's credible performance and the interest displayed by people attending the IHPVA events were major factors in the decision to develop a product

based on Bailey's boat.

Design goals for a production boat include:

- performance that combined stability, seaworthiness, and high propulsive efficiency;
- easy handling by one person, including tool-free assembly and cartopping; and
- manufacture with components and subassemblies supplied by vendors using established manufacturing processes.

Design work and documentation were done on a PC using AutoCad software provided by Jones's design business.

The first production prototypes of the craft, named the *Seacycle*, were built in the spring of 1987. The catamaran/aluminum-frame configuration was retained because it offered an extremely stable, versatile platform, with relatively good drag characteristics. The hulls were shortened to 16 ft. (4.9 m), both to aid in handling and also to allow a more durable hull at the same weight.

The drive system was seen as a key component and was the focus of a lot of design effort. To become a successful product it was felt that several problems evident in earlier pedal-powered boats needed to be overcome. Principal among

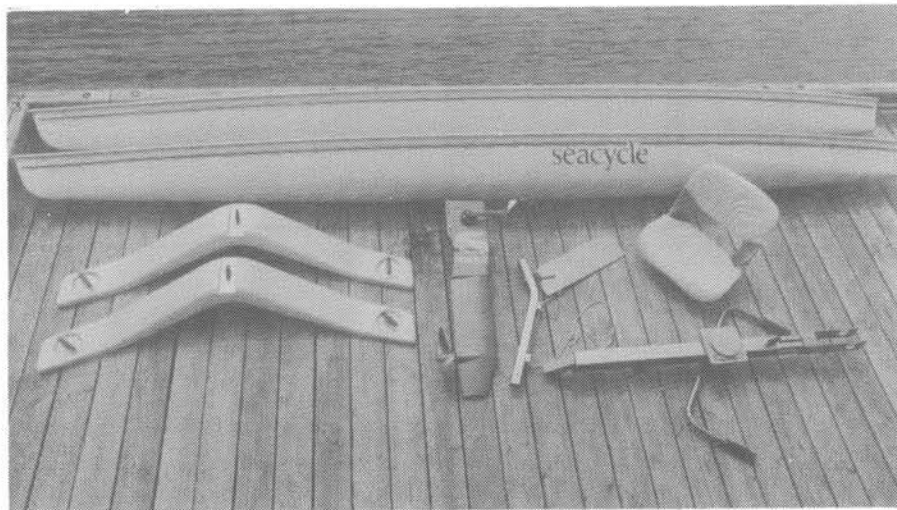

Portable components assemble quickly without tools



The *Seacycle*

them was the prevention of damage to the prop during unintentional grounding. Reliability and mechanical efficiency were also first-order priorities.

The solution selected was to put the drive up front in a foil-shaped housing that extended straight down from the pedal axis. This also enabled the drive to mount and pivot co-axially with the pedal axis. Mechanically simple and thus efficient, the drive is completely enclosed and protected in a hydrodynamically efficient housing that weighed 12 lbm (5.5 kg) including pedals and propeller.

The co-axial mounting allows the drive to rotate about the pedal axis to clear underwater objects without disturbing the rider's pedaling movements. This seemed the best way to protect the drive train from damage when striking underwater obstacles and preventing unintentional ground-

ing. One other benefit that became increasingly appreciated as the new drive was used was the ability to swing the drive up close to the rider and easily clear a fouled prop. One afternoon in water heavy with weeds is all it takes to understand how important this feature is!

The completed prototype weighed 90 lbm (41 kg) and fulfilled the goal of simple, tool-free assembly. The heaviest components were the hulls at 30 lbm (13.6 kg) each. Four hulls could be mounted on a 48-in. (1.2-m) roof rack, and the rest of the components fit in an average-sized car trunk.

Performance testing showed top speeds of 10 knots (5 m/s) and sustainable cruising speeds of 4 - 5 knots (2-2.6 m/s). The craft proved stable in choppy water and tracked well, even in 20-knot (10 m/s) crosswinds.

In November 1988 a Portland marine manufacturer, Recreation Industries Co.(1), purchased Pedal Systems, the company originally formed to develop the Seacycle. Development continued at Recreation Industries. Design changes were made to achieve the following:

- make the Seacycle more suitable for use as a rental at resorts;
- take advantage of new tooling to simplify manufacturing;
- enable switching from a single rider to two riders pedaling side-by-side;
- improve aesthetics to enhance customer acceptance and perceived value.

The prototype boats, as noted, tracked extremely well. Low-speed turning, however, was sluggish at best. Recreation Industries contracted Tom Derrer of Eddyline Kayaks to design a hull with more rocker and increased buoyancy in the bow and stern sections. Overall buoyancy was increased to support two large adults. The result was a dramatic improvement in low-speed turning and a general feeling of improved steering responsiveness. The sometimes unsettling tendency of the earlier boat to bury its bows when riding a following wave was also significantly lessened.

Although tests isolating and comparing the drag of the different hulls was not done, overall comparisons of the two versions indicate hull drag was not significantly increased.

The Seacycle uses a two-bladed 12-in. (305-mm) prop with an 18-in. (457-mm) pitch, driven by a sealed drive unit incorporating a twisted drive chain with a 1:6 ratio. The selection of prop size and pitch was the result of some interesting

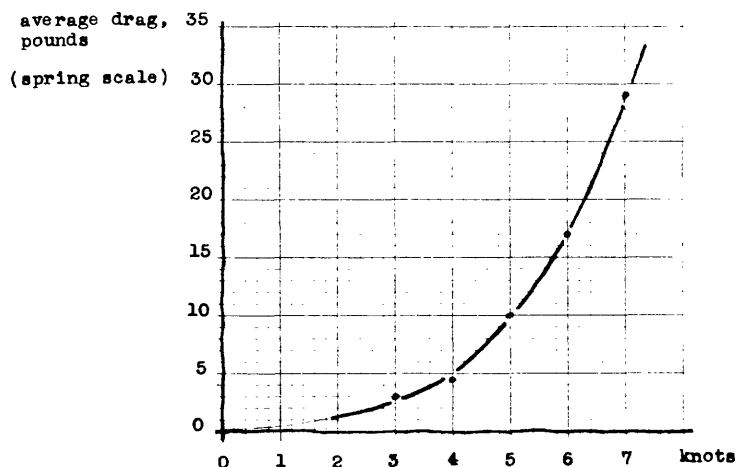

Figure 1. Seacycle drag tests, Willamette River, 11/1/88, including drive unit without propeller, calm slack water, no wind. Weight: Seacycle, 110 pounds; occupant, 180 pounds; total, 290 pounds.

trials with various props and gear ratios.

Four different props ranging in size from 8 in. (200 mm) to 17 in. (430 mm) were tried, each with a range of gear ratios. All prop/gear combinations were tried on the same boat. The boat was pedaled through a known distance at specific cadences and times were recorded.

These trials revealed that virtually all of the prop/gear combinations were capable of driving the Seacycle to 10 knots (5 m/s). Cruising speeds in the 4 to 5-knot (2-2.6-m/s) range were also comparable. Later tests establishing a drag curve for the Seacycle would help explain the results of these tests. The tests showed relatively low amounts of thrust were required to drive the boat at speeds below 5 knots (2.6 m/s) per hour. From 5 - 7 knots (2.6 - 3.6 m/s), however, drag forces nearly tripled.

This rapid increase in drag force overwhelms relatively small differences in propeller efficiencies causing them to look much the same in our tests.

Overall, the selection of prop and gearing played a smaller role in the Seacycle's performance than we had anticipated.

This is not to say prop/gear selections are not important. They have a large impact on how the boat feels when you are pedaling. They determine what cadences can be comfortably used and how much glide the boat has when pedaling is stopped. For example, the highest theoretical efficiency comes from using the largest, slowest-turning prop possible. The moment pedaling stops, however, the prop becomes a surprisingly effective brake resulting in rapid slowing of the boat.

In our view this was an undesirable trait. Imagine riding a bicycle that has extremely poor glide and slows rapidly as

soon as you stop pedaling. It simply makes riding a less pleasurable experience whether on land or water. The 12-in. (30.5 cm) prop selected represented a compromise between propulsive efficiency, pedaling cadence and the ability to let the boat glide.

There were many other design variables that went into the development of the Seacycle. The examples here were chosen to illustrate some of the key considerations in the current design. One important aspect of developing the Seacycle has been the process of reconciling maximizing performance with a kind of "user friendliness". At critical design points, a compromise between maximum performance and functional utility to a perceived market was sought.

We believe successful compromises have been achieved in the Seacycle's blend of performance, safety, ease of use and appearance.

On November 5, 1989, fifth-grade school teacher and triathlon athlete Kym Kucera pedaled a Seacycle non-stop for 25 miles (40 km) across the San Pedro (California) channel from Avalon to Seal Beach in 5 hours, 25 minutes and 26 seconds. Along the way, Kym encountered choppy swells up to 4 ft. (1.2 m) high.

Notes

1. Recreation Industries Co., Box 68386, Oak Grove, OR 97268 USA.

John Foley
14009 N.E. 9th St.
Vancouver, WA 98684
USA

John Foley's background includes a degree in economics from the University of Utah and work as a production manager for several companies building bicycles and Seacycles. □