

# HUMAN POWER

THE TECHNICAL JOURNAL OF THE IHPVA

Vol. 8 No. 2

\$4.00

ISSUE NO. 2726

Spring 1990

## Riding position and speed on unfaired recumbents by Bernd Zwikker

### INTRODUCTION

#### *The aim of this article*

This article, largely based on a series of extensive tests undertaken by the author in 1984 and 1985, is mainly intended as a guide for prospective home constructors who want to take some of the guesswork out of designing a recumbent bicycle. In doing so it also offers an explanation for the intriguing fact that unfaired recumbents are not faster than they are; that is: aren't as fast as one would expect in view of the very large reduction in air resistance possible with a fully recumbent or prone riding position.

#### *The nature of the tests*

It all started back in 1983 when I bought a pioneering Dutch semi-recumbent which proved to be a somewhat exasperating combination of the good and the disappointing. Riding it was quite pleasant, after some small but necessary modifications, but the available top speed was a big letdown: even when I had fully adjusted to the semi-recumbent riding position it was several mph slower than an ordinary drop-down-handlebar ten-speed bike, and in fact even proved to be measurably slower than an ordinary upright old-fashioned city-bike. Both the facts of the case and the probable expla-

nation were at the time hotly contested by enthusiasts with much speculation and very little in the way of hard facts to go upon. Feeling that the basic idea of a semi-recumbent was sound and offered big advantages, but that top speed would have to improve drastically for it to be fully acceptable to one used to riding a ten-speed, I decided to undertake my own measurements.

At about the same time the Dutch University of Nijmegen undertook tests involving a fair number of subjects, comparing oxygen consumption riding this recumbent and riding an ordinary

*(continued on page 10)*

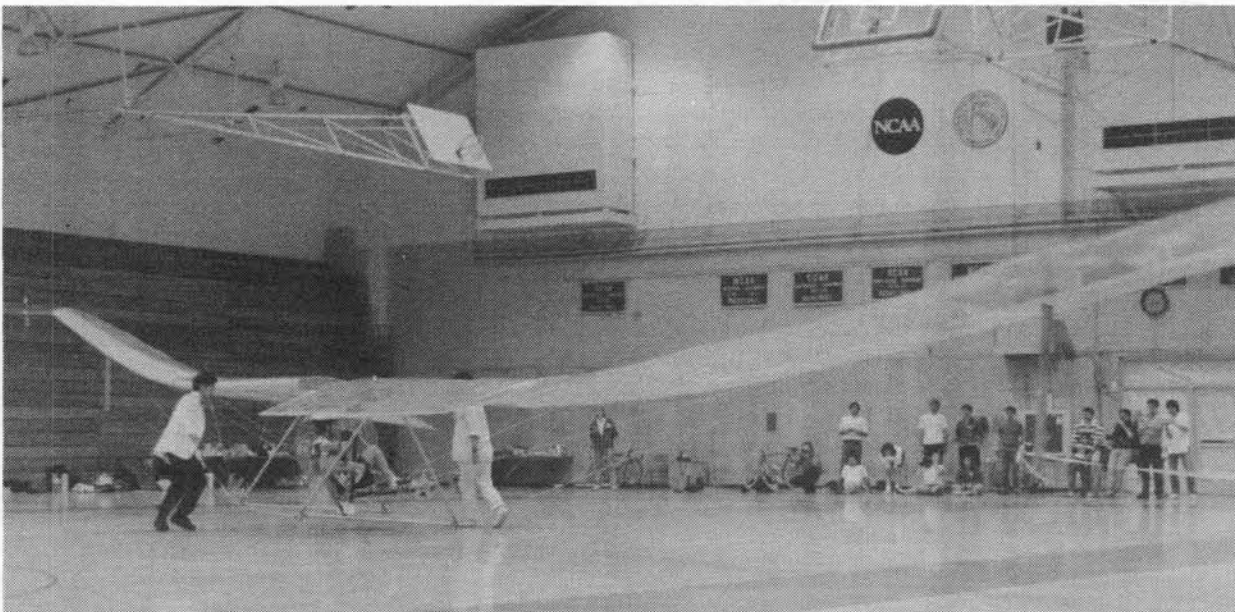

**Free Flight.** Cal Poly Da Vinci III takes off at an angle in hands-off test flight 10 December 1989. Attempt showed that students standing next to craft needed to hold short tethers to ensure rotor didn't hit gym walls. Photo by Doug Johnson. (See editorial.)

## Human Power

The Technical Journal of the  
International Human-Powered  
Vehicle Association

David Gordon Wilson, Editor

21 Winthrop Street

Winchester, MA 01890-2851, USA

(617) 729-2203 (home)

(617) 253-5121 (office)

Theodor Schmidt, Assoc. Editor—Europe

Rebackerweg 19

CH-4402 Frenkendorf, SWITZERLAND

Philip Thiel, Assoc. Editor—Watercraft

4720 7th Ave., NE

Seattle, WA 98105 USA

IHPVA

P.O. Box 51255

Indianapolis, IN 46251, USA

(317) 876-9478

Dave Kennedy President

Adam Englund Secretary

Bruce Rosenstiel Treasurer

Paul MacCready International  
President

Doug Milliken VP Water

Glen Cole VP Land

VP Air

Matteo Martignoni VP All Terrain

Theodor Schmidt VP Hybrid Power

David Gordon Wilson Executive VP

Allan Abbott Board Members

Bill Gaines

Marti Daily

Peter Ernst

Chet Kyle

Gardner Martin

Matteo Martignoni

Dennis Taves

David Gordon Wilson

Marti Daily Executive Director

*Human Power* is published quarterly by the International Human-Powered Vehicle Association, Inc., a non-profit organization devoted to the study and application of human muscular potential to propel craft through the air, in the water and on land. We invite contributions of a longer-term technical interest. Send contributions to the editor or an associate editor at the addresses above. If you would like to be sent a guide on how we prefer the articles be submitted, please write Dave Wilson.

IHPVA membership information is available by sending a self-addressed, stamped business-sized envelope to the IHPVA at the address listed above.

Members may purchase additional copies of *Human Power* for \$2.50 each. Nonmembers may purchase issues for \$4.00 per copy.

Material in *Human Power* is copyrighted by the IHPVA. Unless copyrighted by the author(s), complete articles or representative excerpts may be published elsewhere if full credit to the author(s) and the IHPVA is prominently given.

Special thanks to the authors, Marti Daily, Apple Press, Kim Griesemer and Carolyn Beckman Stitson for major contributions to the production of this issue.

# Editorials

## The future of HPV RAAMS

Some of the participants in the first HPV race across America (1989) treated us to an enthralling account of the event during the IHPVA speed-competition meeting in Adrian, MI, in September. We in the nearly-open-formula human-power movement have been hoping for such an event for years. And it was won in the astonishing time of five days, one hour and four minutes. That should have made the country sit up. But as a competitor in the regular RAAM said, as reported in *Bicycle Guide*: "This is a great race. Too bad nobody in America knows it is happening". I am a "newsaholic", listening to and reading a large number of news accounts every day, but I heard no national news report of this amazing record.

Was it a stunt to attract attention? There is no doubt that we in the IHPVA were hoping that the performances of which modern HPVs were capable would be noticed, and that HPVs would consequently receive more consideration in transportation planning and in sporting events. The IHPVA did not directly sponsor the race, for reasons that have been discussed elsewhere. But we had some input into the arrangements. We were concerned about the safety aspects of the regular-bicycle Race Across America, in which one rider must cover the whole distance. It has developed, inevitably, into a marathon contest of who can last longest without sleep, and riders report hallucinating and other rather frightening mental effects of sleep-deprivation. (Even the most experienced riders also regularly have to give up the race because, principally, of the nerve damage that long-

duration riding on regular bicycles tends to produce). The HPV race removed these dangers almost completely by requiring that the entries be by teams of riders and by limiting the duration that any one rider could be in the vehicle during any one day.

But there were other dangers. One was the speed that a well-faired HPV can attain: over 30 m/s, 70 mph, was reported as being reached fairly frequently on downhills. The interaction of HPVs, sometimes going faster and sometimes slower, with other traffic on the road was another danger. A third was the management problem of supervising a team in a vehicle that may already moving at near the highway speed limit from motor vehicles that are not allowed by law to race ahead to prepare the way or to catch up after a perhaps-minor problem. (The Easy Racer team gave up in Pennsylvania, near the end of the journey, because, among other problems, both the HPV and the support team got demoralized after losing their way several times).

What is the future of the HPV race across America? At present we don't know. But there is no doubt that had there been more public recognition, most of the dangers and the problems would disappear. If this race generated one-tenth of the public excitement of the Tour de France, roads would be closed while the racers passed; the whole route would be marked by signs, spectators, police and officials; and sponsorships would enable managers to have more vehicles, perhaps even helicopters, and more support teams, to give the riders the freedom to concentrate on riding, rather than negotiating a frightening maze of highways and off-ramps full of hostile vehicles. Out of such an event would come HPVs that would demonstrate solutions to some of the lesser, vehicle-related, problems of the 1989 race, and that would have an overwhelming appeal to an exercise-minded public. Thus the wish on the part of the HPV movement to be noticed has some very significant potential consequences.

## Special Human Power on HPBs

The next issue of *Human Power* will be a special issue, edited by Philip Thiel and Theodor Schmidt, on human-powered boats. It promises to be particu-

## In this issue—

<i>Riding position and speed on unfaired recumbents</i> by Bernd Zwickler	1
Editorials by David Gordon Wilson	2
Letters to the editor	3
<i>The "Mercur" long-wheelbase recumbent with rear suspension: construction plan</i> by Werner Stiffel	4
<i>Rear-steering recumbent bicycles</i> by Craig J. Cornelius	6
<i>Cycloid</i> by Miles Kingsbury	8
Book Reviews	9
Reports	13

larly valuable and interesting. I am grateful to them for undertaking this effort, and I know that you will be too. We are open to other suggestions of special topics and special editors: please volunteer.

### Welcome *Cycling Science*

The first issue of *Cycling Science* came out in December 1989 with articles on scientific performance testing, the energy consumption of high-efficiency vehicles, the future of the mountain bike, hard facts on bicycle helmets, carbohydrates and bicycling performance, and the aerodynamics of handlebars and helmets. *Cycling Science* was started by Ed Burke and our own Chet Kyle, co-founder of the IHPVA, partly to fill the void left by the demise of Rodale's *Bike Tech*. We wish them luck in a very difficult publishing world. And we hope that they are read by Rodale's *Bicycling*. We were visited by *Bicycling's* technical editor recently on another matter, and found that he had never read nor even heard of *Human Power*. Should we be advertising in *Bicycling*?

Subscriptions to *Cycling Science* are \$19.97 per year, \$36.97 two years, from Cycling Science Publications, P.O. Box 1510, MT Shasta, CA 96067.

### Congratulations Cal Poly!

The Da Vinci human-powered helicopter lifted off for 7.1 seconds on Sunday, December 10, 1989 before official observers. This is a big step along the way towards the \$20,000 Igor I. Sikorsky prize of the American Helicopter Society, which requires a sixty-second flight three meters above the ground. This machine, pictured on our cover, is the fourth helicopter built by Cal Poly students, who started in 1981 on the quest, and it incorporated some ingenious features that solved difficult problems. We have asked project manager Neal Saiki and AHS student president Margaret Whelan to let readers of *Human Power* know more technical details of their achievement.

—Dave Wilson

## Letters to the editor

### First Japanese solar boat race

(This is an amalgamation of two letters, less information given in HPV News, from Toshio Kataoka, who acts as HP's correspon-

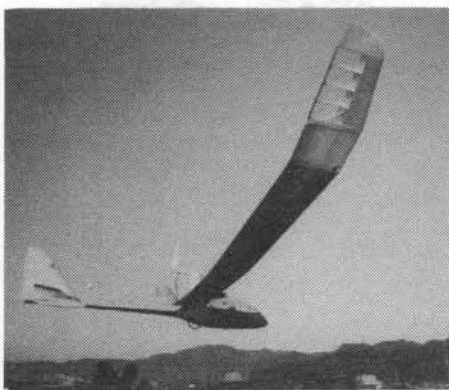

HPA Yamaha Birdman Rally Team

dent in Japan. We are very grateful for his efforts! The increasing scale and scope of human-power activity in Japan is certainly impressive.—ed.)

My friends and I entered this event July 30, 1989. However, we had to retire after developing problems. The first place was a proa—a monohull with a side pontoon, taking 35m 18s for 6.8 km. Second place was a solar-powered hydrofoil (the first in the world?) at 54m 10s. In third place was a trimaran, at 55m 10s. We also had the solar-car grand prix on July 31.

Other human-powered news is that a group of handicapped Japanese men crossed Canada in arm-powered vehicles, finishing on July 25, 1989. The Japanese solar-car team ("Hama-Zero") placed second in the Canadian solar-car race in August. The team leader, Mr. Hajime Yamawaki, who also organized the solar boat race, plans to enter the 1990 World Solar Challenge across Australia, starting in Darwin on November 11. There was another solar-car rally in Asahi, Japan, in September.

The annual Japanese Birdman Rally [this is a wonderful event for human-powered aircraft and gliders that take off from a tall jetty and crash-land in the harbor—ed.] was almost a disaster be-

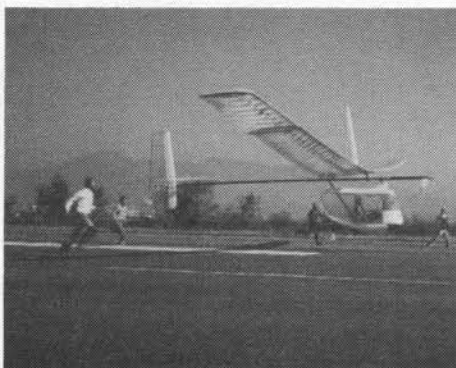

HPA Toyota Birdman Rally Team

cause of unfavorable winds. I was invited by Mr. Suzuki of Yamaha to the HPA exhibition and meeting in Fujikawa on December 4, 1989. Two HPAs were exhibited. One was the entry of the Yamaha Birdman Rally team, with a 22-m wingspan and an all-composite structure, controlled by rudder and elevator. It flew 300-400m several times. The other was the Toyota Birdman-Rally HPA. This flew shorter distances, 100-200m, several times, but then crashed. The team is planning to fly again February 4, 1990.

Toshio Kataoka  
422-2-101 Renkoji  
Tama-shi Tokyo JAPAN 206  
Tel. 0423-38-3818

### Whitehead responds

Regarding Rob Price's response to my letter published in HP 7/4, page 16, I would like to invite him and other interested readers to realize that nothing magic happens when a vehicle's cornering pivot point moves forward on the extended front axle line. This *must* happen as tire-slip angle increases, which anyone can see by drawing simple geometric diagrams like the first figure in my article to be published in HP 8/3. If the turning circle radius is large enough, the turn center can be forward of the front axle for *small* tire-slip angles (no drift) in which case the front steer angle is small and its tire-slip angle exceeds the steer angle. This condition is the rule for speeds above 15-20 m/s.

Thanks to Rob Price for pointing out that it can be a useful endeavor to define a region of drift such that the vehicle is drifting when the turn center crosses into this region. The boundary of this region moves forward of the vehicle as it moves away from the vehicle, rather than following the extended line of the front axle.

John C. Whitehead  
JCW Engineering  
3322 Biscayne  
Davis, CA 95616

### HPV building in the thirties (HP 7/3/89)

A fine, informative article by Arthur Baxter, with much food for thought. However, one key point appears to be incorrect.

Mr. Baxter states that:—"The circular pedal motion (on a recumbent) wastes power."—"It is much harder to raise the foot on a recumbent bike than on a normal (upright) bike."—"Much of the

(continued on page 16)



## Principal required materials

- 1 old men's bike frame 28" or 26"
- 1 front wheel 32 x 369 (Moulton 17") or 37 x 340
- 1 rear wheel 28 x 440 or 47 x 407 with hub gear and if possible with drum brake
- 1 handlebar
- 1 pedal crank bearing and chain set (with 68-tooth large ring if a derailleur is used)
- 1 spring element 50-mm diameter, 120-mm long of polyurethane of density 0.65 g/cc: drill 12-mm dia hole using high speed
- 20 m tape or belt material 15-mm wide for the seat
- 3 nylon bushes with 8-mm diameter hole, 20-mm long, outside diameter to fit corresponding tubes
- 210-mm rod, 8-mm diameter for trailing-arm bearing; must be threaded at each end for 15 mm
- 750-mm tube 30 x 1, (or use old cycle tubing, but the joint is more difficult to make)
- 300-mm tube 12 x 1 for the spring
- 3 x 410-mm tubing 10 x 1 for diagonal struts\*
- 2.7 m tubing 20 x 1 for seat
- 1.26 m tubing 20 x 1 for bow frame  $H_1, H_2$
- 169 mm tubing 22 x 1.5 for trailing-arm bearing tube
- 170 mm tubing 20 x 1 for upper lateral strut (trailing arm)
- 2 x 380 mm tubing 10 x 1 for diagonal struts DG
- 2 x 180 mm tubing 10 x 1 for telescopic struts
- 2 x 200 mm tubing 12 x 1 for telescopic struts
- 2 x 190 mm tubing 10 x 1 (cycle top tube) for lower lateral tube
- 170 mm tubing 24.8 x 1.5 (cycle top tube) for lower lateral tube
- 170 mm tubing 20 x 1 for upper lateral tube
- 170 mm tubing 10 x 1 for rear lateral tube
- 300 mm tubing 12 x 1 for spring
- 1 handlebar connecting tube from mini-bike

\*"3 x 410-mm tubing 10 x 1" means "three

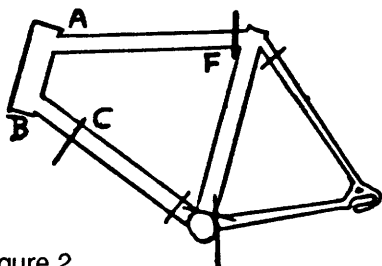

Figure 2

pieces of tube, 10-mm od x 1 mm wall, 410-mm long"

## Preparation of the old frame

Saw up frame at the positions indicated. Distance BC is taken from the complete side-view drawing and 20 mm is added for filing. The bottom bracket still has a bit of tubing onto which the new bottom tube 30 mm x 1 mm is pushed. The other three holes are sealed by brazing or gluing on appropriate bits. Place the front part of the frame on the 1:1 scale drawing and check the angles. If they don't coincide, heat at head tube and bend, taking care not to pull apart or unbrazed the joints.

## Making the main frame

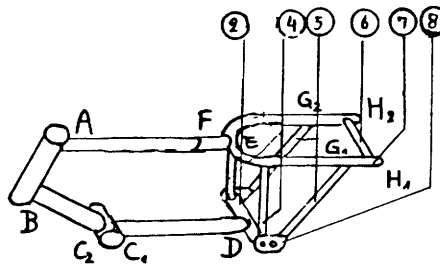

Figure 3

2-lower lateral tube; 4-support struts; 5-diagonal struts; 6-back lateral tube; 7-bow frame; 8-trailing-arm eyes

Push tube  $DC_1$  onto the short piece left on the bottom bracket and braze on. Butt join tubes EF and AF with interior tube made of (e.g.) rolled sheet. Place tubes DCBAFE onto drawing and underlay with bits of wood until everything is one plane. Then protect drawing and spot weld at  $C_2$ , check and braze. Then put frame vertical, check angles, and braze on lower lateral tube (2). Bend bow frame  $H_1, H_2$  around template, as described earlier, to a radius of about 80 mm. Flatten top tube slightly at E and

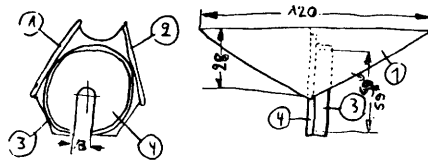

Figure 4

1-left reinforcement; 2-right reinforcement; 3-support ring; 4-bearing plate

## Alternative A

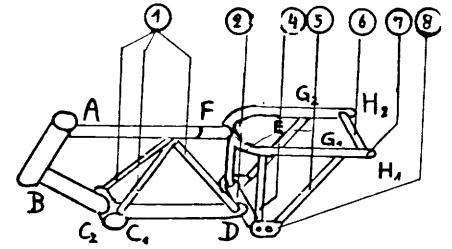

Figure 5

1-diagonal struts; 2-lower lateral tube; 4-support struts; 5-inclined struts; 6-back lateral tube; 7-bow frame; 8-trailing-arm eyes

braze onto bow frame. Braze on vertical struts, forward seat for spring (see later) and back lateral tube.

For heavy-duty use the frame can be strengthened by using three diagonal struts (1).

## Alternative B

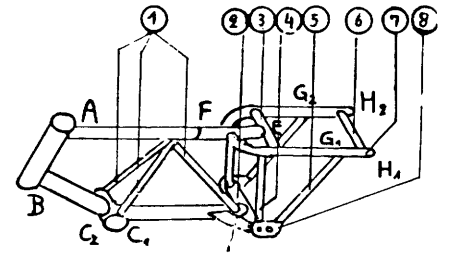

Figure 6

1-diagonal struts; 2-lower lateral tube; 3-upper lateral tube; 4-support struts; 5-inclined struts; 6-back lateral tube; 7-bow frame; 8-trailing-arm eyes

For extra-heavy-duty use, the back end of the bow frame (7) can be modified. The upper longitudinal tube is extended, slightly flattened, and the upper lateral tube (3) brazed on left and right.

The bow frame (7) is halved and brazed on.

The lower lateral tube (2) is supported additionally on the left or on both sides by connecting plates.

## Making the trailing arm

Cut the lower struts exactly to length and file ends round corresponding to the bearing tube. Then bolt the two back assemblies to the rear wheel (without tire); hold onto bearing tube such that wheel is central on this; fasten temporarily with two spot-welds each; check that

(continued on page 14)

# Rear-steering recumbent bicycles by Craig J. Cornelius

## Summary

The benefits of a rear-steering recumbent bicycle have inspired a number of individuals to build single prototypes that were usually very difficult to balance. Over a ten-year period the author has built seven different rear-steering recumbent prototypes, each demonstrating improvements in the rider's ability to balance it. While the most current variation is not as stable as its front-steered counterparts, it does demonstrate that a rear-steered recumbent bicycle can be made to perform satisfactorily as a racing vehicle.

## Experiments with rear-steering recumbent bicycles

Most HPVers have more sense than to tangle with the concept of a rear-steering recumbent bicycle, or RSRB for short. Those who let their curiosity get the better of them usually build only one prototype and their inability to ride it results in them writing the concept off as a bad idea. Some of us are suckers for lost causes.

## Why rear-wheel steering?

One unimaginative engineer told me, with the conviction that one expects from a religious Zealot, the concept was "just plain wrong". But are existing recumbent designs beyond reproach? If one views the front-steering recumbent bicycle, FSRB, with some objectivity, present designs exhibit a number of problems not manifest in the upright bicycle. Long-wheelbase designs are difficult to transport and have lightly loaded front wheels, often of different diameters because gearing considerations favor a large rear wheel. Long-wheelbase designs also tend to be somewhat heavier than other approaches. Short-wheelbase designs have too much weight on their small front wheels leading to higher rolling resistances and potential stability problems. Medium-wheelbase designs either place the rider too high off the ground or have potential foot/front-wheel-interference problems. All designs require an overly long drive chain to connect the front-mounted pedals with the rear drive wheel.

Contrast these design deficiencies with a hypothetical front-driving RSRB whose stability problems have been solved. The wheelbase can be similar to that of an upright bicycle, on the order of 1020 mm (40 in.) The weight distribution can be near 50/50, and two identical 686-mm (27-in.)-dia. wheels can be used. The pedals can be located near the drive wheel; a conventional-length drive chain can be used. If the handlebars are located under the seat, they can be placed near the steered wheel. If the stability problems could be overcome, all these design improvements could be realized in a RSRB.

caster. Caster, or positive trail, is defined as the distance the steered wheel's ground-contact patch is behind the intersection of the steering axis and the ground, behind being defined as opposite the direction of desired motion. Positive trail results in a torque being developed whenever the plane of the steered wheel is not aligned with the direction of motion. For small steering angles, this torque is roughly proportional to the steering angle and acts to reduce the steering angle. As a result, any disturbance to the steering angle is corrected for by the negative feedback associated with positive trail.

Disturbances to lean angle are corrected for by the phenomenon of lean-steer. The kinematics of a typical bicycle are such that the tendency of the system to reduce its potential energy results in a torque that steers the bicycle in the direction that it is leaned. As a result, a disturbance which causes the main frame to lean sideways initiates a turn in the direction of the fall. The radial acceleration due to that turn results in a force that acts to lift the bicycle out of the fall. As with positive trail, lean-steer results in negative feedback to the disturbance that initiates it.



## Front- and rear-wheel steering stability

What makes front-steering bicycles, FSBs, stable and rear-steering bicycles, RSBs, unstable? In its simplest form a bicycle can be thought of as a two-mass system. The larger mass is made up of the main frame, the rider, the driven wheel, etc. and the smaller mass is made up of the steering frame (fork), steered wheel, handlebars, etc. The rider maintains stability by directly controlling system velocity and steering angle, and lean angle indirectly. During a steady-state maneuver, either riding in a straight line or executing a constant-acceleration turn, the two major system perturbations are to steering angle, which primarily relates to the steering frame, or to the lean angle, which primarily relates to the main frame. A correctly designed FSB has a mechanism to correct for each of these disturbances.

Disturbances to the steering angle are corrected for by the phenomenon of

The mechanisms of positive trail and lean-steer allow a bicycle to be ridden with the rider's hands off the handlebars. In addition these mechanisms are usually strong enough to allow a bicycle to remain upright in the absence of a rider above some minimum speed. The auto-stability of an FSB is a direct result of positive trail and lean-steer. Fortunately, both mechanisms occur together in an FSB.

In an RSB, positive trail results in reversed lean steer and conversely, lean-steer is present only with negative trail. I have investigated numerous combinations of fork offset and fork rake for single-pivot steering systems, as well as a number of four-bar-linkage positioning mechanisms, and have not found a steering method that combines both positive trail and lean-steer. This inability to obtain both disturbance-correcting mechanisms in the same configuration is why RSBs are inherently unstable. In

designing a simple RSB, then, one must choose among positive trail, lean-steer, or a neutral configuration that exhibits neither phenomenon.

### RSRB experiments

I constructed my first RSRB out of plywood during the summer of 1978. It had 508-mm. (20-in.) wheels and used a four-bar-linkage wheel-positioning mechanism having no rake and providing about 76 mm. (3 in.) of negative trail. The seat height was about 152 mm. (6 in.) and the bicycle was, for all practical purposes, unrideable.

In 1981 Jerry S. Onufer and I decided to build an adjustable-configuration RSRB to duplicate and elaborate on the research conducted by Lee H. Laiterman on RSRBs in 1976 and '77, as part of his undergraduate thesis at MIT. Laiterman investigated the effects of trail, wheelbase and steering-control parameters on stability. His bicycle had a seat height of 610 mm (24 in.), a B.B. (bottom bracket) height of 432 mm (17 in.), a seat-back angle of 70 degrees, 508-mm (20-in.)-dia. wheels and a vertical steering axis. He apparently did not investigate fork-rake angle. A paper on tire-slip-angle effects convinced him that negative trail was the desired configuration, and although he investigated both positive and negative trail configurations with fork offsets up to 203 mm (8 in.), he selected his minimum negative trail of 25 mm (1 in.) as the optimum configuration. When one considers that tires have some inherent amount of pneumatic caster, use of a slight amount of negative trail may have actually resulted in a

neutral configuration that exhibited neither caster nor lean-steer. RSRBs require some type of steering-control linkage that reverses the direction of the inputs. Laiterman used a cable-pulley system that had a very forgiving input/output ratio of 2.5:1. He also concluded that short wheelbases are more stable than long wheelbases and settled on 875 mm (35 in.) In a private communication David Gordon Wilson confided that Laiterman's RSRB was "almost impossible to ride". Onufer and I wanted to find out how difficult "impossible" was, since it had to be easier to balance than my first RSRB, if only by merit of its seat height.

The MK I adjustable RSRB used 508-mm (20-in.) -dia. wheels, had a 508-mm (20-in.) seat height, an almost-vertical seat back, a 406-mm (16-in.) B.B. height, a wheelbase between 1020 and 1270 mm (40 and 50 in.), a single-pivot steering fork that could be angled up to +/- 30 degrees from vertical, and fork offsets up to 100 mm in 25-mm (4 in. in 1-in.) increments. Refer to the photo. Steering control was via a rod with spherical bearings and the control input/output ratio was about 1:1. With the exception of the adjustable fork rake and steering control, the MK I was similar to Laiterman's RSRB.

When we attempted to ride the MK I, it became apparent that independent of fork offset and rake, we could not ride the RSRB from a stationary condition. If one were supported until a critical balance speed, CBS, was reached, it could be ridden for fork-rake-and-offset configurations that resulted in all positive trails and small negative trails. Getting started from

a stop appeared to be the major obstacle to rear-wheel steering.

During the summer of '81, quite a few approaches were evaluated in an effort to get started unassisted. Some were quite bizarre. It was becoming clear that above the CBS the positive-trail configurations seemed easier to control than negative-trail configurations and that fork rake had little beneficial effect. It was then that I recalled an 1869 velocipede in the book *Wheels and Wheeling*. The Laubach Velocipede had a semi-recumbent posture, (as did many velocipedes), and its frame was articulated so the vertical steering pivot was located beneath the seat. Since the seat was attached to the front frame, along with the drive wheel, it was technically a RSRB. It had 927-mm (36.5-in.)-dia. wheels and the trail was about 508 mm (20 in.) While the modern author concluded the vehicle would have been very difficult to manage, contemporary reports were much more favorable.

With the Laubach velocipede in mind, I extended the trail to 305 mm (12 in.) Performance at speed was improved and the CBS was lowered but unassisted starts were still not possible. It is interesting to note Laiterman's observation regarding large positive trails. "Increasing the trail surprisingly did not make handling worse, as expected, but rather prevented oversteering from occurring at the beginning of the turn. However, once the turn had been completed, the bicycle seemed reluctant to pull out of the turn and return to a straight course." The next step was to increase the trail to 610 mm (24 in.) At this point the bicycle had a wheelbase of 1600 mm (63 in.) and the C.G. was close to the front wheel. The 610-mm (24-in.) trail was sufficient to allow for unassisted starts and although it felt strange and the handlebar forces were large, it could be easily balanced. A large amount of positive trail seemed to be a solution to the problem of starting.

In the four design variations that followed, the intent was to maintain the large positive trail but to minimize some of the negative factors associated with that approach. The MK-II variation substituted a vertical-pivot four-bar linkage for the single-pivot wheel positioner. The RSRB's wheelbase was reduced to about 1070 mm (42 in.) and the instant center of the steered link was located about 914 mm (36 in.) in front of the rear wheel's axle. The trail was therefore 914 mm (36 in.) when the wheel was centered but was

(continued on page 17)

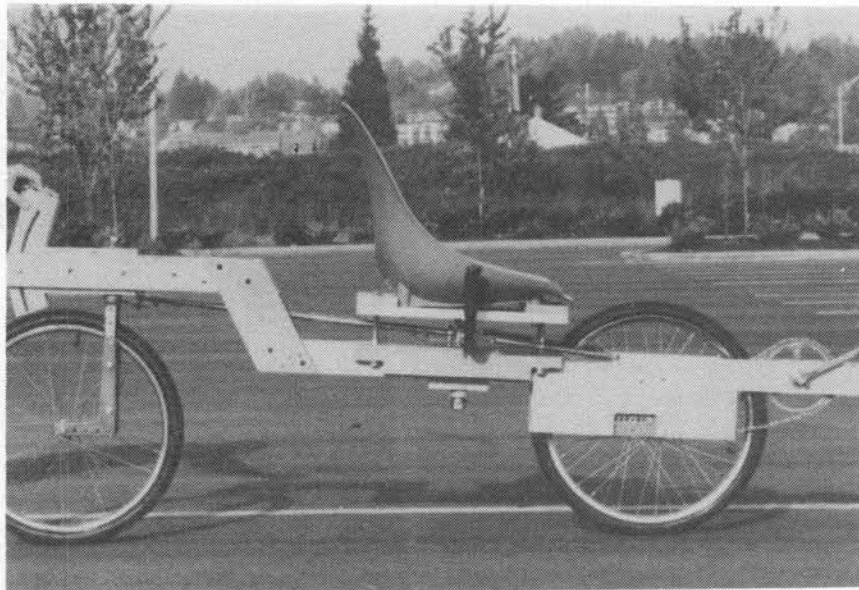

The MK I adjustable RSRB

# Cycloid

by Miles Kingsbury

Here is some information on my latest H.P.V. The drive is only about 90% as efficient as rotary motion at present, but we are confident this can be improved by altering the shape of the eccentric. I won the 1988 UK championship weekend best all 'rounder on this vehicle on its first outing in its cloth covered form.

The advantages of the drive system are:

- Produces a very small frontal area which therefore increases maximum speed.
- Produces a sinusoidal motion at the crank which is very efficient and 'feels' the same as standard rotary motion (Bicycle).
- The chain does not move up and down during the pedal cycle. This means it can be enclosed in a tube or

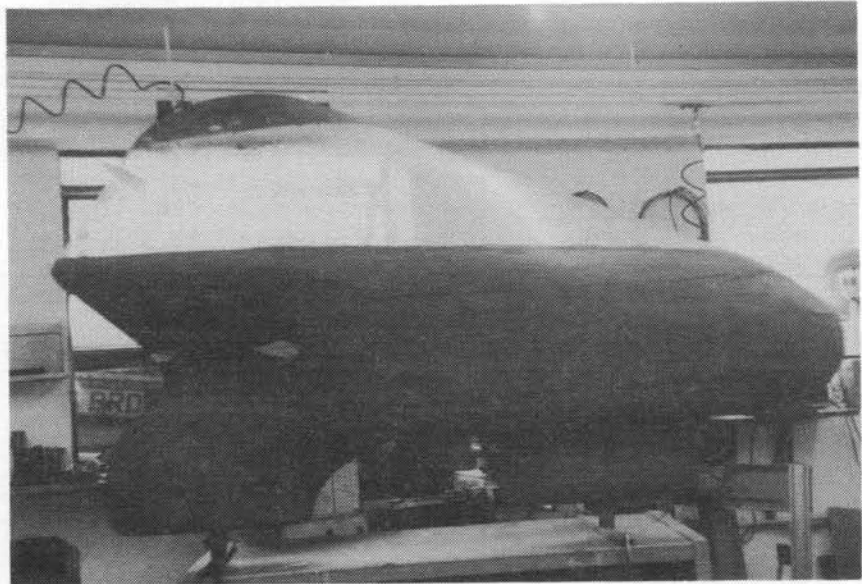

Styrofoam plug of fully-faired version of Cycloid

- under a cover which eliminates the oily trouser leg.
- There is no need for gears as the rider can change the length of the stroke to maintain a comfortable pedalling rate.

- Could easily be adapted to a standard upright bicycle.  
Miles Kingsbury  
26 Dedmere Rd.  
Marlow, Bucks SL7 1PG  
UNITED KINGDOM

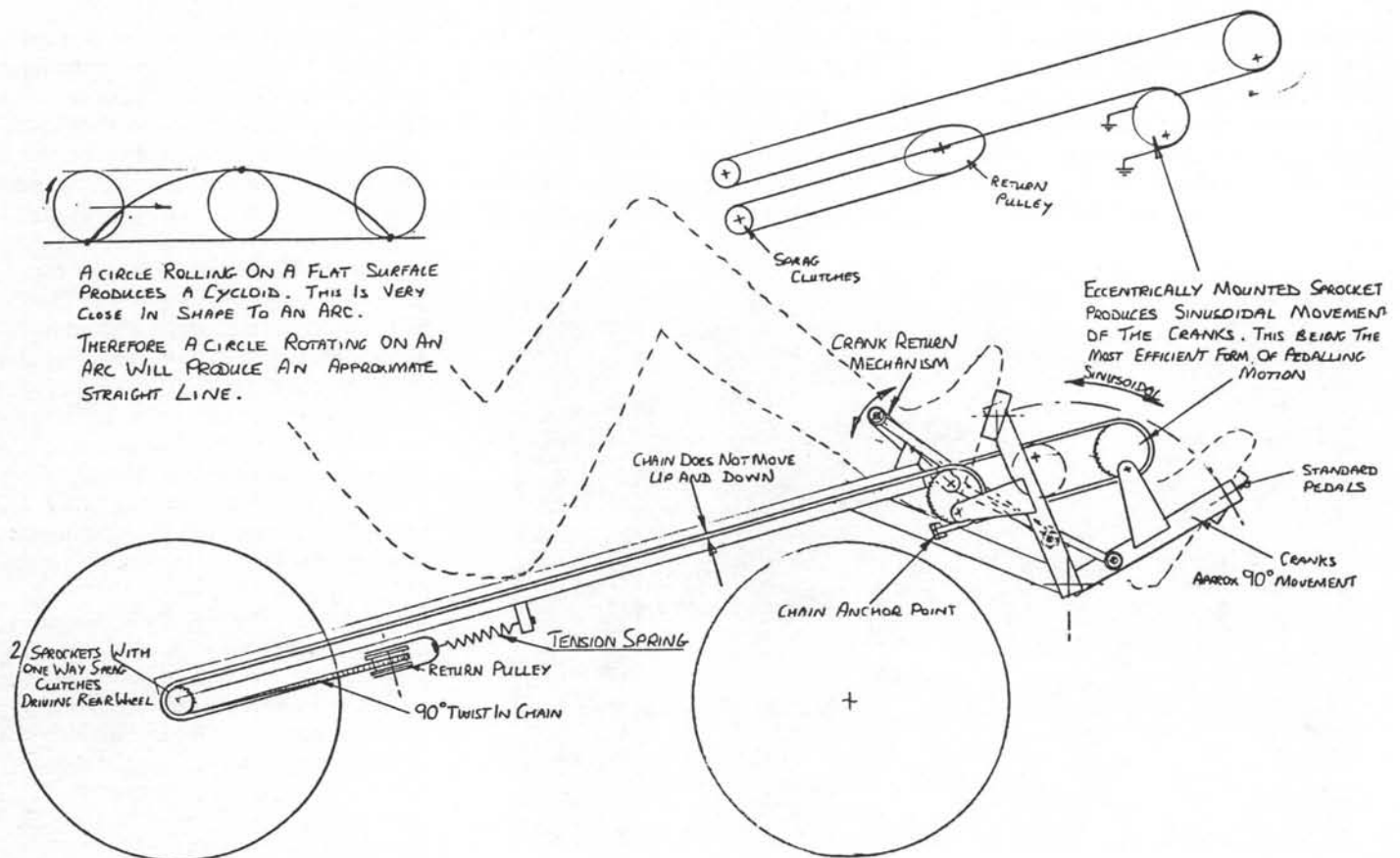



## Book reviews

### Upgrading Your Bike by Frank Berto

This book is going to cost me a lot of money. I've always found Frank Berto's tests of derailleurs and similar components in *Bicycling* and *Bike Tech* the most valuable articles in those publications, and I eagerly sought the chance of reading and reviewing his book. It is much more than a collection of his articles. He categorizes bicycle use into "racing", "sport touring" and "loaded touring" (the last category fits most commuting), and first discusses economics before going into details of front and rear derailleurs, shifting systems, chains, pedals, wheels, tires, tubes, brakes and saddles. I found myself agreeing with him so completely in those areas in which I had some knowledge that I can accept with great faith everything else he writes. His analysis showed exactly why I get such poor shifting on both front and rear derailleurs, and he gave me a way out of the problem of rear-wheel-spindle breakage that has plagued my Avatar 2000. I jotted down what I need to upgrade my recumbent: it will cost about what I would have to pay for a good conventional bike, but I know that it will be worth it. He also explained why I sometimes have trouble with the various tires and rims that I seem to have accumulated.

This is a great book! No HPV builder should be without it. It is published by Rodale Press, and it is priced at \$14.95 in paperback and \$19.95 hardcover.

### Designing and Building the HPV Composite Fairing by Tom McGriff

Tom McGriff of HuDyn Vehicles (P.O. box 22444, Indianapolis, IN 46222) has written an in-house-published book full of very useful practical information on producing rigid aerodynamic composite fairings. I am a gross amateur at making fairings, and I have produced several that have turned out to be nonrigid, not very good aerodynamically and to have looked rather disgusting. I wish that I could have had Tom McGriff's book before I had started. It consists of 61 pages of double-spaced typescript and probably twice that number of good, simple sketches. It has step-by-step instructions as well as some overall considerations on principles. Write to Tom for information on availability.

—Dave Wilson

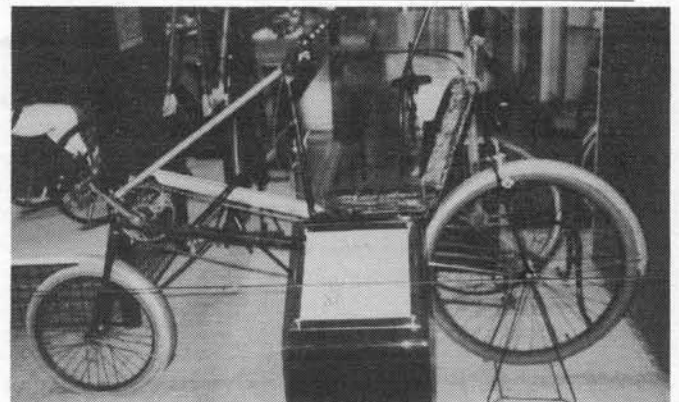

French recumbent bicycle from the 1930s. Photo by Koshio Kataoka

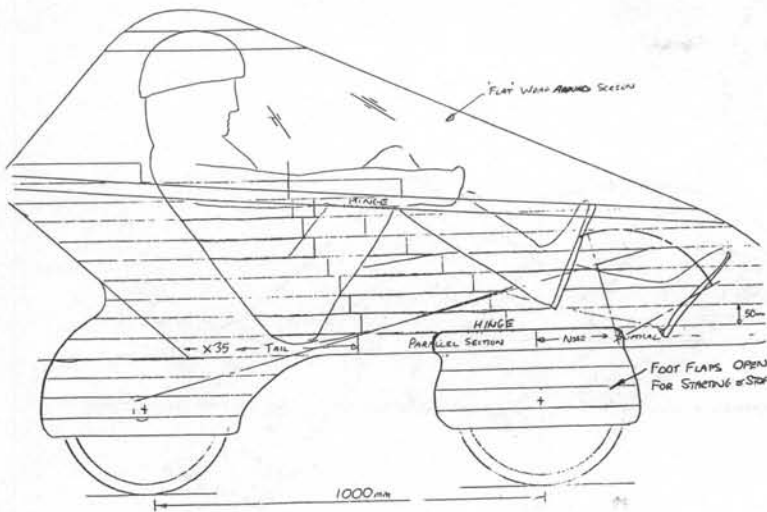

Cycloid side view

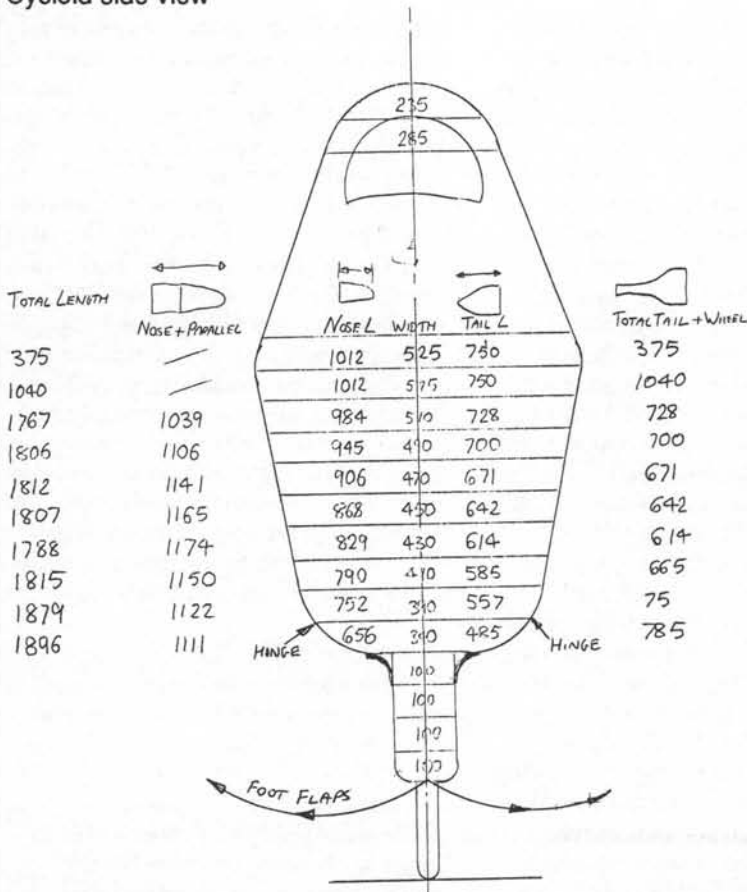

Cycloid front view

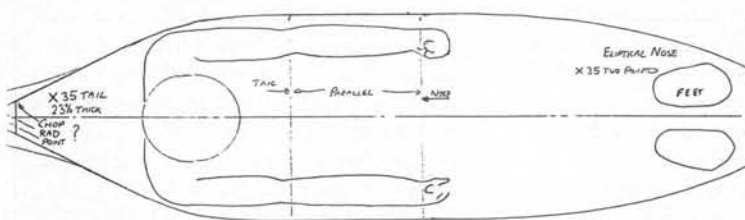

Cycloid top view

## Riding position and speed on unfaired recumbents

(continued from page 1)

three-speed upright city-bike of the type commonly used in Holland for shopping and short-distance commuting.<sup>1</sup> All their measurements were done at slower speeds and the results were somewhat ambiguous as the subjects were not used to riding a semi-recumbent, while it also was inherently impossible to separate the effect of reduced air resistance from differences in efficiency of the riding position itself. However, to check out the latter, additional ergometer tests were held that suggested that biomechanical efficiency was equal and any differences should be attributed to lower riding resistance. In these tests the semi-recumbent turned out to be somewhat better than the traditional bike, which did nothing to explain the poor results I experienced at higher speeds.

For my own tests, I started by using a combination of low-speed coast-down tests and downhill equilibrium-speed tests to determine rolling resistance and air resistance (taking a textbook-derived figure for the much lower transmission losses). These measurements were done alongside similar measurements using a conventional six-speed upright touring bike and a drop-handlebar racing bike, the latter ridden in three different riding positions. From such data it is, of course, possible to calculate the power required at different speeds and under different circumstances. The results of these calculations were similar to those done by the University of Nijmegen and therefore went only part way to explain the top-speed differences. As a next step I decided to calculate the actual power output under real-life circumstances by measuring the attainable top speed when climbing a short 6% incline, both with the racing bicycle and with the semi-recumbent, and using the figures obtained earlier about air resistance, rolling resistance and mechanical efficiency to calculate the power delivered to the pedals at this speed (which in fact was largely dominated by the power needed for the actual climbing, helping to improve considerably the accuracy of the end result). Additional tests of a similar nature helped to isolate other factors contributing to the poor top speed of this particular recumbent, such as insufficiently positive location of the body while exerting more than moderate force on the pedals. The

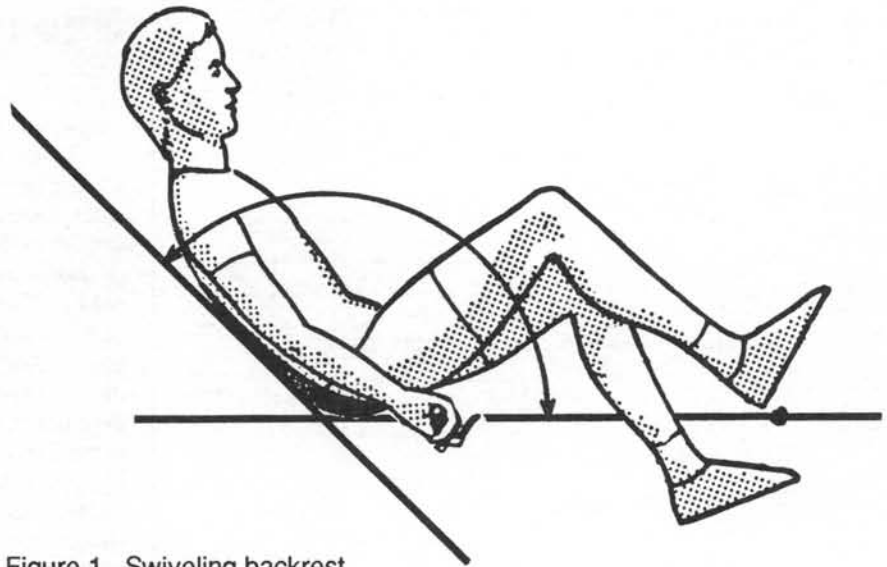

Figure 1. Swiveling backrest

conclusion of the tests, which were published in a Dutch bicycling magazine,<sup>2</sup> was that a number of factors were responsible for the slowness of the recumbent, of which one of the more important was that, in the riding position used (in which the legs were more or less in line with the upper body), it was clearly impossible to deliver as much power as in the riding position of a conventional racing bike.

At a later date I was able to do a number of similar tests on a different semi-recumbent, where the bracket was placed rather higher (about 200 mm [8"] beneath seat height) and the seat featured a small swiveling backrest, rather like that of a typist's chair, which moreover could easily be adjusted to give any riding-angle (defined as the angle between the global inclination of the rider's back and the imaginary line connecting the crank axle with the lowest point of the seat; see Figure 1) between 115 and 145 degrees. Moreover, the combination of beneath-the-seat steering and the self-adjusting backrest ensured that changing the riding position did not have any untoward side effects, such as reducing the positive location of the upper body. This therefore allowed measuring directly the effect of changing the riding angle, again using the racing bike as a comparative transfer-standard. The results reaffirmed that changing the riding position has a marked influence on the maximum output of the rider, as well as proving that in the most effective semi-recumbent riding position the power delivered to the pedals did not measurably differ from the power delivered on the racing bike.

The third series of tests was similar in kind, but used a third semi-recumbent,

built to my design using the input of the earlier tests, which featured a bracket at seat height as well as a more conventional type of seat of which the backrest could be adjusted over a smaller range, giving a riding angle of between 118 and 125 degrees. These tests were merely used to check the predictions made on the basis of the earlier tests, and when these were affirmed, further tests were canceled.

Besides these main tests, additional tests were held throughout in different circumstances and under less rigidly controlled conditions, to give additional checks on the accuracy of the main measurements and the calculations based upon them. These did not give rise to doubts about the basic accuracy of the method involved, fitting in well with the trends observed on the main tests.

### *The scope of the tests*

Throughout, much care was taken to make the measurements as rigorously scientific as possible within a small budget. The choice of real-life tests rather than ergometer and wind-tunnel tests, while made imperative by lack of funding, actually served to make the tests more representative of the actual conditions under which a bike normally is used. While doubtless measurements made out on the road are less exact than those made in the laboratory or wind-tunnel, there is at least no worry about ignoring the important ground-effect (caused by the vehicle moving over the stationary ground), or about ergometer testing imposing unrealistic conditions on the rider. In the same way, the choice to test high-power efficacy, rather than measuring oxygen use or taking the

heart-rate as an indicator while the rider is making a more moderate effort, was a deliberate one, as I felt that the effects causing the recumbent in question to be too slow might not show up on low-speed trials (as proved indeed the case). To ensure the most accurate results possible, all measurements were done in extremely still air, while all measurements were repeated at least three times, and in most cases four times, to check for consistency.

Scientifically speaking, the real weakness no doubt lies in it being a one-person study, using myself as test-rider. One important advantage of this is that I was used both to riding an ordinary racing bike as well as the recumbent in question, which had been in daily use for about a year when the first tests were held. Moreover, to further reduce the risk that what was measured would simply be the effect of being insufficiently trained, I undertook a regular training program using both the racing bike and the recumbent for two months before the tests. However, using only a single subject does mean its scientific status can never be more than that of a preliminary study showing where further research would be most useful.

Unfortunately, we all know that definitive and exhaustive scientific work on this subject is not likely to materialize in a hurry, as it would have to involve large groups of volunteers, each of which would have to be equally well-trained in riding a conventional bike as in riding a recumbent. So we'll have to make do with what is actually possible.

Still, when considered just as a guide for beginners embarking on the difficult subject of designing a recumbent that suits whatever design criteria are put down by the maker, I have considerable trust in it. Especially as it's not solely based on the tests described above, but also on several years' daily experience, on an ongoing analysis of racing results, using as input both the results of the recumbent races held monthly during the season since 1984 in Holland and the published results of the IHPSCs held in the USA, and—last but not least—regular discussions with other experienced (recumbent) cyclists on the subject.

## THE FACTORS INVOLVED

### *Changing the inclination of the backrest*

It is, perhaps, an understandable expectation that the more you tilt back the upper body on a recumbent, the faster you will go. You might then envision touring recumbents with a relatively

upright position to improve the rider's view of the road and make keeping equilibrium easier, and almost supine ones to be used primarily for racing. But if you construct an experimental recumbent with adjustable backrest, you'll find things aren't as simple as that. In fact, as long as you keep all else the same, you're likely to discover, as I did to my surprise, that changing the inclination of the upper body over a considerable range has absolutely no measurable effect on top speed at all, at least on a level road. Now it's undoubtedly true, and easily confirmed by coasting downhill, that the nearly supine position offers a markedly lower air resistance than the semi-recumbent; so to explain the phenomenon there must be a second factor compensating for this.

To explain this, it is necessary to recall the definition of the riding angle as the angle between an imaginary line linking the crank-axle with the lowest point of the seat, and the global inclination of the rider's back (Figure 1). Now it is clear that, all else being the same, changing the inclination of the backrest will change the riding angle, and it is this change that is to blame for the disappointing lack in speed increase. In fact, this is not really surprising. If you examine any good textbook on ergonomics, you are likely to find something like Figure 2, which indicates the general trend of available maximum force you can exert with your legs as a function of increasing angle between legs and upper body.<sup>3</sup> Now force is not the same as power, and the positions in which the

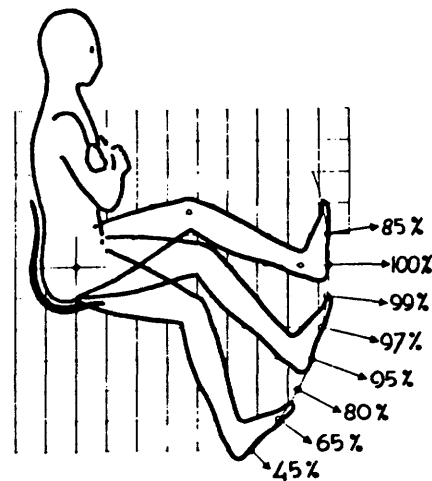

Figure 2. Available maximum force of legs as function of increasing angle between legs and upper body

greatest force can be exerted are too cramped to be suitable for cycling anyhow, but still it's not, after this, surprising that increasing the riding angle decreases the power available for propulsion. To be otherwise, the reduced force would have to be compensated for by a commensurate increase in maximum pedaling speed, which in my experience is not possible.

In fact changing the riding angle from a near optimum of 120 degrees, corresponding to a maximum output equaling that on an ordinary ten-speed drop-handlebar bike, to what I personally consider the maximum suitable for use on a general-purpose recumbent, namely 135 degrees, gave a measured drop in maximum output of about 6-7%. While this may not look like much, it already makes a marked difference when climbing hills.

So we have a clear trade-off between air resistance and ergonomic quality, and it means that just increasing the inclination of the backrest does not, in general, help to make your recumbent faster.

### *Changing the gross body position*

Now the preceding has a interesting and, perhaps, unexpected corollary. For if you change the gross body position while keeping the position of legs relative to upper body the same—that is, change the inclination of the backrest and the height of the bracket relative to the seat at the same time so that the riding angle doesn't change—you do have a way to influence top speed after all. For tilting the rider backwards reduces the air resistance while keeping available power the same.

If you combine the above with the earlier finding that changing the inclination of the back—everything else remaining the same—has no measurable effect on top speed on a level road, an even more interesting fact emerges. Taken together, this means that the crucial factor influencing the basic speed capabilities of a (semi-)recumbent is not, in fact, the inclination of the rider's upper body, but the height of the bracket relative to the seat, the higher meaning the faster.

This apparently surprising outcome has been fully confirmed by my tests, but there still remains an important factor we have failed to discuss. If you change the gross body position, you change the relative direction in which gravity exerts its influence on the rider's body.

### *Relative bracket height*

Unfortunately, here we introduce a subject of conflicting data. At least two

experienced recumbent designers have reported strong adverse effects of a relatively high bracket position, while on the other hand I know several Dutch recumbent enthusiasts of many years' standing using bikes and trikes with the bracket placed markedly higher than the seat (usually up to 200 mm [8"] higher, in one case even over 350 mm [15"] higher) who are quite satisfied and do not report any difficulties riding them at all.<sup>4</sup>

So whether there is a real intrinsic disadvantage for the average enthusiast in using a high bracket remains unclear. Obviously in such cases you need to use Look or similar pedals in order to ensure a positive connection between shoe and pedal. But apart from that, does it really mean that you get increased problems with lactic acid build-up in your leg muscles? Is riding like that inevitably more cramped? In view of the central importance of the question to the possibility of building really fast unfaired recumbents for touring and everyday use, this is clearly a subject for further systematic study.

As it is, the data are insufficient for me to reach a firm conclusion. On the one hand, it may simply be that some people are more sensitive to the adverse effects associated with high-bracket designs than others. On the other, it may be that not the high bracket in itself is to blame, but that the problems noted stem from some combination of high bracket and smallish riding-angle.

Setting aside the matter of possible side effects of high-bracket design, my experiments with long-wheelbase semi-recumbent bikes featuring under-the-seat steering have firmly reinforced the expectation that top speed capability is closely linked to bracket height. In fact, placing the bracket markedly lower than the seat meant a top speed measurably lower than on a common ten-speed bike, while placing it higher gives the possibility of a higher top-speed. By chance, the point where the top-speed of this type of semi-recumbent and that of the conventional ten-speed match, comes with placement at about seat height.

In view of the uncertainties about side effects, I would not advocate placing the bracket more than 75 mm [3"] higher than seat height, unless you have a chance beforehand to find out for yourself how it works out for you, either by borrowing a similar bike or by building a cheap and cheerful prototype first.

As to placing the bracket lower than the seat, in my experience placing it up to

about 180 mm [7"] lower gives a very comfortable, rather upright riding position that is extremely pleasant and highly suitable for touring, though at the price of a certain speed loss, comparable perhaps to choosing a conventional touring bike with mountain-bike handlebars rather than drop-down handlebars. However, I would not advocate any lower placement as I see no real advantage in that.

As far as I myself am concerned, my own choice (not wanting to incur even a slight speed disadvantage in comparison with the conventional ten-speed touring bike I was used to) has been to place the bracket at seat height, and I am quite satisfied with it, feeling that, combined with a modest riding angle of 121 degrees, it gives an excellent compromise between speed and comfort and makes the bike highly suitable for use in both city traffic and touring.

My other main recommendation would be to avoid excessively small or excessively large riding angles. Keeping the riding angle between 120 and 135 degrees will most likely lead to satisfactory results. On the basis of personal experience, I would also advocate at least trying out a riding angle of about 120 degrees as I have found this vastly superior to a larger one. It not only enables one to choose a more upright riding position for a given relative bracket height (which helps in steering and keeping one's equilibrium, also in enabling the rider to see more and be seen more easily by others) but also that, at least for me, it makes climbing much easier and allows me to ride longer before my legs get tired.

### *Ergonomics*

Going on personal experience (both my own and others'), the most important ergonomic difference between the moderately upright optimum position equaling a riding angle of approximately 120 degrees and a more stretched-out riding position, is apparently that with the latter a much larger part of the power has to be delivered by the quadriceps femur, while in the optimum position a larger additional contribution from the hamstrings and gluteus maximus helps lighten the task. This means that, in the latter case, one reaches the point where the quadriceps are exhausted (by lactic-acid build-up or otherwise) much sooner, while it also appears that top speed is limited by available leg-power rather than by cardiovascular capacity. A further disadvantage is that one is more susceptible to knee-strain due to overenthusiastic hill-

climbing. I would argue then that the ergonomic equation should not be given less priority than the aerodynamic one.

Of course, there remains the question of training. In theory, one might expect that concerted training of the quadriceps could counteract this unfortunate side effect of taking up a more aerodynamic position without comparable adjustment of bracket height. After several years of riding a semi-recumbent with a large riding angle and without yielding much in the way of adaptation, I am highly skeptical of the possibility of training to compensate for a less-than-optimum riding position. I can say only that changing to a smaller angle came as a decided relief.

While it is my opinion that one should be warned against an excessively stretched-out riding position, I would also like to point out that an excessively small riding angle (less than, say, 118 degrees) makes for a cramped and unpleasant riding position which discourages spinning at high rpm and is better avoided.

On the whole, it has been my experience that more satisfactory results are achieved if the ergonomics are carefully optimized, even at the cost of increased air resistance, than the other way round. I believe therefore that ergonomic considerations should have a high priority, which makes it dangerous to trust too much to measurements of air resistance and rolling resistance, or even measurements based on oxygen consumption or heart-rate at moderate levels of exertion, as the main means of assessing the qualities of a recumbent. However useful in their own right, such measurements might well fail to reveal serious ergonomic shortcomings that become fully apparent only when actually climbing a hill, battling against a strong headwind or riding long distances.

### **CONCLUSION**

The height of the bracket relative to the seat is of primary importance to the top speed of a (semi-) recumbent where, within reasonable limits, higher equals faster. If no gross design faults are present (i.e., insufficiently positive location of the upper body, extremely unsuitable tires or excessively heavy construction leading to uncommonly high rolling resistance, very high transmission losses, unacceptably flexible frame construction, etc.), relative bracket height is a decisive factor for unfaired designs, comparable to relative handlebar height in conventional

bicycles. Unfortunately, there is serious doubt about the suitability of high-bracket designs for longer distances in view of supposed adverse effects on lactic-acid build-up, although more data on this point are needed. In view of this it seems likely that practical unfaired recumbents shall have to be (depending on the compromise chosen by the designer) either somewhat slower than conventional bikes, equal to or somewhat faster. Making recumbents much faster than the conventional alternative would inevitably have to involve some sort of full-scale fairing, with all the attendant problems where use in busy traffic is concerned, i.e., susceptibility to side-winds (especially with bikes and less so with trikes), poor view of the road immediately in front and usually lack of ease in getting into and out of the fairing.

However, the fastest unfaired recumbent bikes, where the bracket is higher than seat height but not so high as to cause serious problems are, on the basis of extrapolation from my data, likely to be about as much faster (ca. 1 m/s [2 mph]) when compared with a drop-handlebar racing bike, as a racing bike is compared with an old-fashioned upright touring bike. The advantage is by no means negligible, especially when this higher speed is combined with a vastly more pleasant and comfortable riding position.

## REFERENCES

<sup>1</sup>A. Boonstra and W. Canton, *Energiegebruik tijdens het fietsen op een ligfiets en een toerfiets*, University of Nijmegen, 1984.

<sup>2</sup>J. and B. Zwicker, *Hoe licht gaat the lage fietser?*, *Fiets* 7/84 (June 1984) and 8/84 (September 1984).

<sup>3</sup>Drawing supplied by Dutch designer ir. A. Tauber.

<sup>4</sup>D.G. Wilson reported the occurrence of serious leg strain with high bracket design in his contribution to James C. McCullagh, *Pedal Power*, Rodale press, USA, 1977; and elsewhere, too, has shown himself an eloquent advocate of placing the bracket relatively low; while the HPV-constructor Charles Brown, in *Human Power*, vol 5, no 2 (summer 1986), reported tiredness setting in excessively fast with a high-bracket design and after further experimentation concluded that placing the bracket more than 75 mm [3"] above the seat height had better be avoided. Until more conclusive data arrive, I tend to go along with this.

Bernd Zwicker  
Nicolaaslaan 19  
3984 JA Odijk  
THE NETHERLANDS

*(Bernd Zwicker is a member of the board of directors of the Dutch HPV association NVHPV and editor of its journal HPV Nieuws. He spends much of his spare time either riding recumbents or writing about them.)*

## CHARLES BROWN COMMENTS

*(I asked Charles Brown to comment on Bernd Zwicker's article, especially with regard to the height of the pedalling center —ed.)*

The results of my tests with unfaired semi-supine recumbents agree closely with Bernd's. I used to experience discomfort pedalling these bikes when the bottom bracket was much higher than the seat. This effect seemed repeatable with several bikes, even one with an adjustable seat built to study this, so I duly reported the results in HP 5/2/86/3.

Then I met Jon Stinson, who outraced me on an unfaired bike with raised bottom bracket. This re-opened the investigation, and I am now happily riding around on bikes that have the bottom bracket 70-50mm (3-6") higher than the seat, without discomfort.

Perhaps the considerable flexibility of my early bike frames was at fault, or maybe I've just gotten more used to recumbents over the years. We definitely need more input before a final consensus can be reached.

Laying the seat back too much causes the rider to waste pedalling energy bouncing his or her torso up and down. Raising the bottom bracket allows a second aerodynamic advantage by allowing the seat to be laid back farther before this bouncing begins.

I build a small lump into the seatbacks of my bikes which fits the indentation of the lower back area. This gives the seatback a little more grip so that I can lower the seatback a little more.

With this lump in place, with the bottom bracket 50mm (2") higher than the seat, I like the seatback 50 degrees from horizontal. With the bottom bracket 180mm (7") above the seat, I like the seatback 44 degrees from horizontal.

If a more-horizontal seatback is desired, consider securing the rider's body by other means, such as a wide belt to keep the pelvis from moving, or

shoulder braces as on the "Velocar", or Arthur Baxter's racer (HP 7/3/89/24).

From a few tests, I am convinced that having the handlebars in front of the chest creates less air drag than having the arms at the sides. Handlebars under the seat were designed for safety, not speed, so this hardly settles the controversy.

Charles Brown  
534 N. Main, #1  
Ann Arbor, MI 48104  
USA

## Reports

### The Ocelot SWB recumbent bicycle

A Brisbane barrister (that's a lawyer), Doug Young, took a year off to design and build the recumbent bicycle shown in this drawing from *Professional Engineering* (Inst. Mech. Engrs., UK), and then won the gold medal at the prestigious Geneva, Switzerland Salon International des Inventions et des Techniques Nouvelles. This is regarded as the world's foremost design forum and prize. Perhaps IHPVA developers should be entering their creations there.

Doug Young, who is described as a rowing and fitness fanatic, has certainly received a great deal of publicity for his development, which should help the whole human-power movement. We learned most from a clipping sent by Alan Stewart, an IHPVA member in Brisbane. The rider puts work into the bike through the hands and feet. The hands must move together, but the feet can move in phase or out of phase with each other and with the hands.

—Dave Wilson

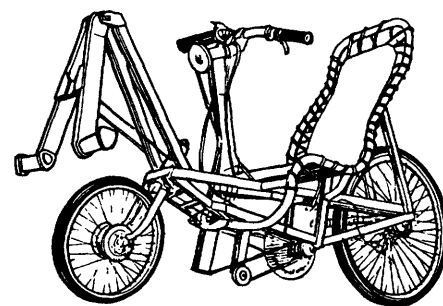

The Ocelot bicycle, as printed in *Professional Engineering*, June 1989

# The "Merkur"

(continued from page 5)

wheel axis and trailing-arm-bearing axis are parallel, and braze. Then adjust the angles of the upper struts, either by heating and bending gently or by debrazing and rebrazing at correct angle. Cut off struts to correct length and braze on upper lateral strut and vertical struts, and braze on eyes for rear spring bearing tube (1), tap M6 and seal with screw M6. [I believe that "M6" means "6-mm-OD thread—ed]. Press in nylon bushes. Attention! the upper struts (4) must be long enough that the upper lateral struts (2) should not hit the mudguard when the spring is fully extended.

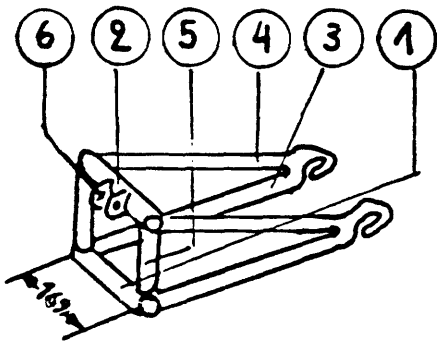

Figure 7  
1-bearing tube; 2-upper lateral strut; 3-lower struts; 4-upper struts; 5-vertical struts; 6-eye for spring bearing

If you make the trailing arm asymmetrical, you can use a symmetrical (undished) rear wheel, which is stronger.

## Preparing the fork

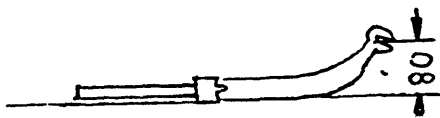

Figure 8

A standard fork gives too much trail with the head angle used here, so the fork must be bent more in order to give a trail of 40 mm. Put the fork in a vise (protected with pieces of aluminum) and bend tubes singly to reach a displacement of 80 mm. Check symmetry. For attaching the fender and perhaps caliper brakes braze in strut, e.g. tube 20 x 1 mm squashed oval with brazed-in tube 8 x 1 as hole reinforcement.

For direct steering, a long steering tube is advantageous (less movement of handlebars).

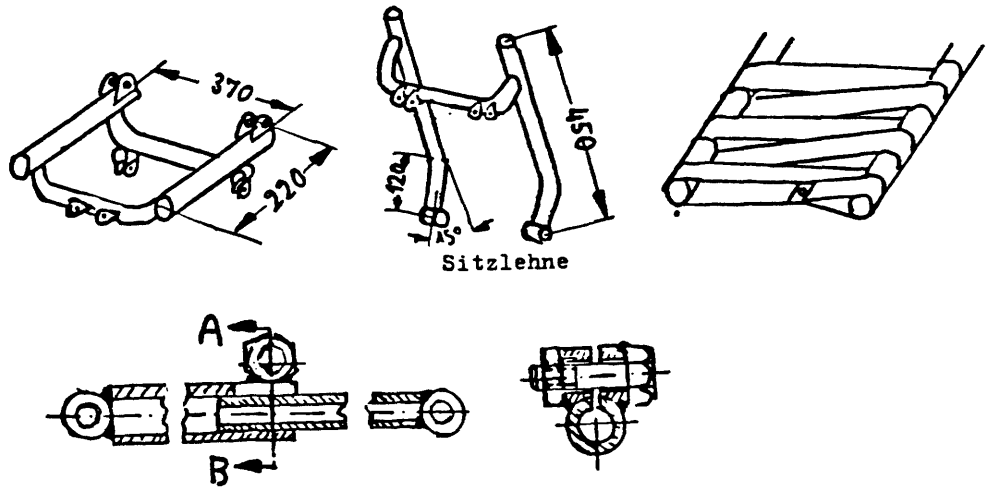

Figure 9. Telescopic struts for adjustable backrest

## Making the seat

Close the ends of the tubes with rubber or wood plugs (to avoid injury). Wind the seat tape according to sketch, going across only every other time: this saves tape and promotes ventilation. Fix the ends with M4 screws and large washers both made of brass.

### Alternative

If the above seems too complicated, use the fixed arrangement shown here. If you make the seat 400-mm wide and the backrest 500-mm high, you can use material instead of tape for the seat (e.g. the very good seat material sold by Kurt Pichler, Mittlere Kirchgasse, Heidelberg, W. Germany).

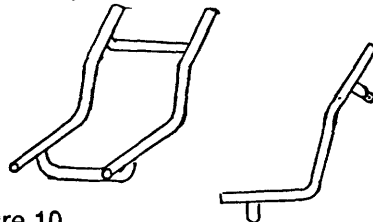

Figure 10

## Making the spring

On to 120-mm-long 12 mm x 1 mm tube, braze small 20-mm-long tube 22 x 1.5 as bearing. Then press in a nylon bush. At other end braze in M8 threaded rod (e.g. a screw with the head cut off) so

that it protrudes 35 mm and is at least 5 mm inside tube. Besides the soft rubber spring elements (2 shown), some nylon spacers are threaded on for adjusting the length and on the other end a rubber washer and also some nylon spacers as an end stop. Finally put on a wing nut.

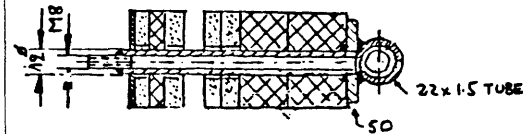

Figure 11

Depending on the position and range of the spring it may be necessary to place the front eye for attaching the spring somewhat forward to backward. In this case the length of the spring must be made accordingly, e.g. 300 mm instead of 120 mm and the extra length taken up by a larger spacer tube slipped on the spring tube.

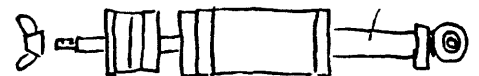

Figure 12. Shortening the rubber makes the spring harder.

## Making the handlebar

Use a standard 400 mm-long handlebar attachment but straighten and saw off the eye. Then take a second handlebar attachment from, e.g., a small-wheel shopping bike and braze on according to sketch. (File off chrome before brazing).

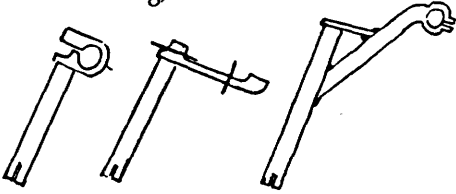

Figure 13. The handlebar itself can be a flat one.

It is easier to use a "Chopper" or "Easy Rider" type high handlebar than the construction described.

If the steering arrangement is too floppy for your liking, you can strengthen it according to sketch. A tube 10 x 1 is flattened and an eye made for the top attachment and a short piece of tubing brazed on for the bottom attachment, which is bolted on at the hole for the caliper brake. In the middle a piece of sheet with a large hole is held by the head set nut and acts as a strut.

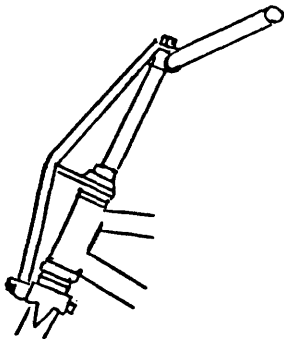

Figure 14

This arrangement can however reduce the available steering angle.

## Fitting together

Bolt eyes for the trailing arm onto lower lateral tube with threaded rod M8. Fit fork, trailing arm, spring, wheels, seat, etc. and make the two wheels parallel by sighting, loosening trailing-arm eyes, adjusting, and retightening. Test-drive to see if it rides straight and doesn't pull right or left. When everything is okay, take trailing arm off, having marked the places where brake cables run over bearing tube, so that small pieces of nylon can be screwed onto these places. Braze

the trailing-arm eyes; remove threaded rod and plug holes with e.g. rubber plugs. Now the diagonal struts can be brazed into place.

## Fitting out

### Front brake

Drum brakes or center-pull caliper brakes are good; side-pull brakes can easily foul the cranks.

### Rear brakes

Caliper brakes hinder the removal of rear wheel, so use drum brakes or "cross" brakes, in which case the appropriate fittings must be brazed onto the trailing arm.

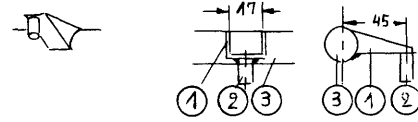

Figure 15. 1-fitting for "cross" brake; 2-bearing bolt; 3-trailing-arm tube

### Fitting the brake cables

A continuous sheathed cable to the rear brake would have too much friction and elasticity. Therefore the arrangement shown can be used, which also allows one to use two shorter lengths of brake cable.

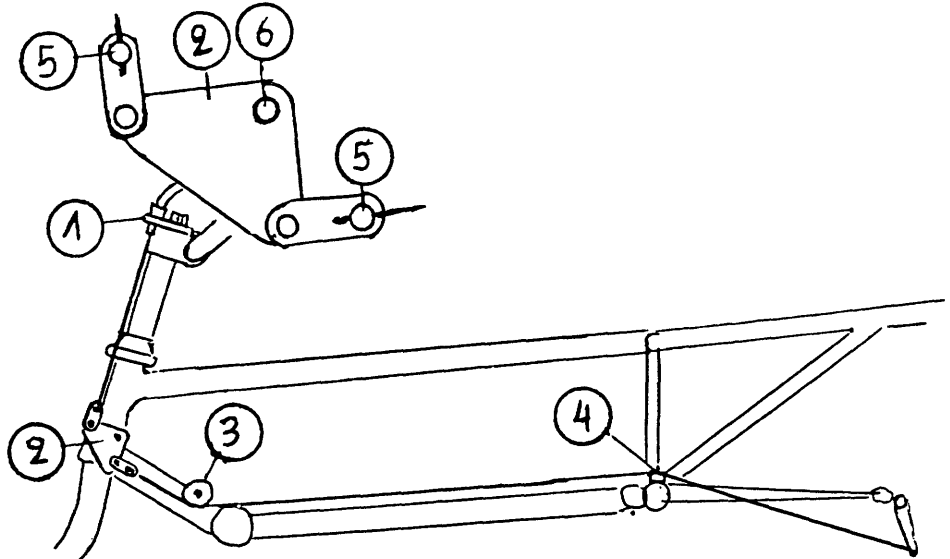

Figure 16. 1-Stop for sheath with threaded adjustable screw; 2-Lever; 3- Pulley; 4-Nylon pieces; 5-Adjustable screw; 6-Pivot

### Tensioning the chain

A chain tensioner near the middle of the chain prevents excessive sagging and shaking, the chain jumping off, too much tension on any fitted derailleur, and grime getting on trousers. For this an old derailleur can be used.

Old derailleur as central chain

tensioner: remove rivets holding on parallelogram cage and fasten with M5 screws through rivet holes onto brazed-on fitting.

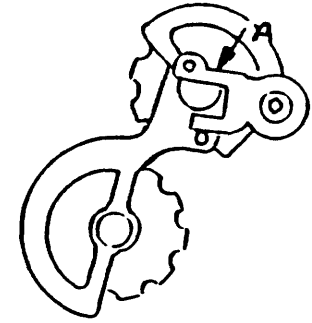

Figure 17

If a rear derailleur is used, a simple guide pulley is sufficient, as per sketch.

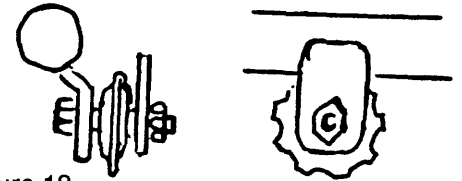

Figure 18

### Bottom bracket

If the junk frame used doesn't have undamaged threads, in the bottom bracket various threadless sealed pedal crank bearings are available, FA6.

### Mudflap

This is useful for the front wheel, attached to mudguard and reaching to about 20 mm above the ground.

### Chain Rattle

To lessen rattle from the chain touching the bearing tube on the trailing arm, glue on rubber or similar material.

**Indirect steering**

I also tried the Merkur with indirect steering using push-rods. If you want to do this, choose a head angle of 75-80 degrees, although 60-65 degrees is also possible.

The handlebar is fastened to a "head set", which is shortened to 45 mm. by means of a brazed-on "u" eye. See sketch. As a push-rod use thin alloy tube, e.g. an old cross-country ski pole with attached steel ball joints. These are attached to steering eye with M7 bolt and to fork crown with brazed-on M7 bolt.

**CONCLUSION**

Please, work with the greatest care, as a brazed joint which breaks going fast downhill can literally cost you life and limb! You could also be liable to damages to other people. Also laws could be tightened up following too many accidents, causing severe restrictions to our entire human-power movement.

Werner Stiffel  
Huebschstrasse 23  
D-75 Karlsruhe  
WEST GERMANY

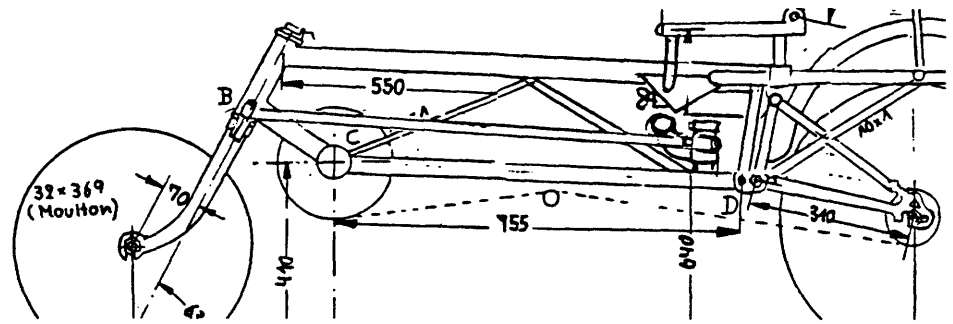

Figure 19

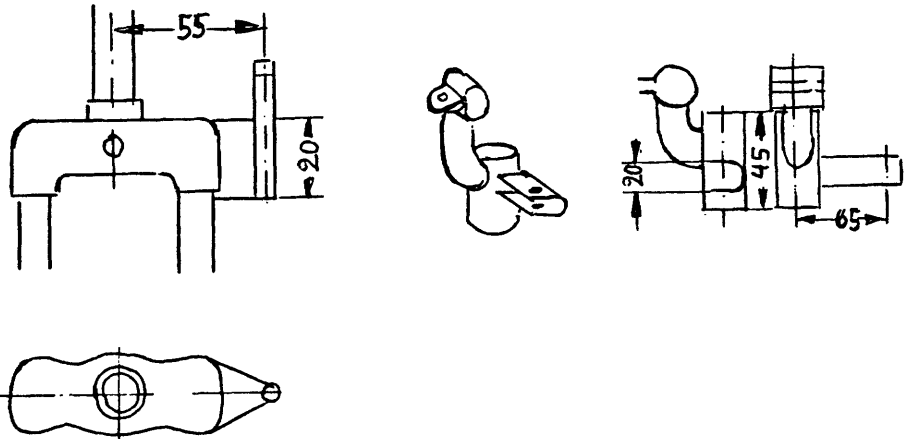

Figure 20

**Letters to the editor**

(continued from page 3)

power of the falling foot (on the recumbent) is wasted in helping the other one up to the top." Etc.

These statements are misleading. They do not seem to consider the fact that both on recumbents and on "normal" upright bikes the weight of the rising leg is counterbalanced by the weight of the falling leg. Ignoring friction losses, the net work required to raise and lower both legs should be zero.

I've oversimplified in order to make the point. Actually the geometry of legs, pedals, seat location, etc., complicates things somewhat. The net turning forces on the cranks from leg weight alone vary from a positive (helping) force of say 3 to 5 lbs., to a negative (hindering) force of the same 3 to 5 lbs., over each 90 degrees of pedal turn. Magnitudes of these forces are about the same whether the bike is a recumbent or an upright. See Figures 1 and 2. Actual forces depend on actual leg weights, system geometry, etc. Since the helping force makes the bike go forward, and since the amount of work required to

overcome the hindering force is exactly equal to that performed the helping force,

(which is "free"), the net extra work required to overcome leg weight is zero.

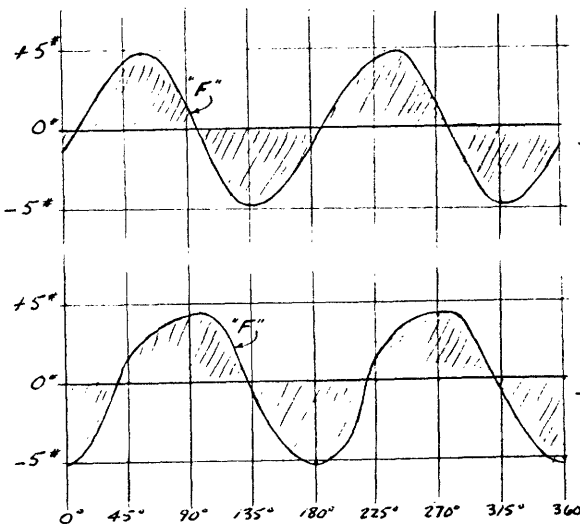
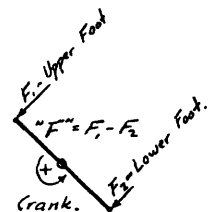

Fig 1 - Recumbent Bike

Fig 2 - Upright Bike

NET TURNING FORCES (F'') ON CRANKS DUE SOLELY TO WEIGHTS OF LEGS & FEET.

1. Positive forces turn cranks forward.
2. Negative forces turn cranks backward.
3. Areas under curves are work done.
4. Positive areas equal negative areas for any one bike.





A further help, (if any were needed), in minimizing extra work required to lift a leg is the flywheel effect of a rotating foot and lower leg, which would eliminate a substantial portion of any negative force to the pedal. (A fixed gear bike would provide a flywheel effect which would be sufficient by itself to overcome all the negative forces to the pedals).

Figure 1 shows the effect of the weight of a hypothetical pair of legs on a recumbent bike's cranks, pedalling in a circular motion. Figure 2 shows the effects of the same pair of legs on a "normal" upright bike. Note that while net forces are shifted to different points on the pedal circle, the overall shapes of the curves and their general magnitudes are very similar. (Curves were drawn from Elliott calculations. Calculations are lengthy but can be forwarded if desired.)

Conclusion. When considering forces required to overcome the weight of legs pedalling cranks in a circular motion, there does not appear to be a significant difference between recumbents and normal upright bikes. Any actual work required appears small, which then leads to the second conclusion that pendulum crank motion for recumbents would not seem to have a significant energy advantage over circular motion.

H. M. (Mac) Elliott P.E.  
6616 N. 14th St.  
Phoenix, AZ 85014  
USA

### Sprung recumbents

Regarding Rob Price's article in the spring-89 HP on steering and suspension design, since riding a recumbent bicycle with suspension is so nice, maybe we could get a member to write an article on how to build a simple recumbent-bicycle suspension system. . . . I figure, as a nontechnical person, I may be able to build one, but designing is another matter altogether. Another similar idea for HP would be an article on recumbent-frame building . . . . I get so much out of HP articles and I really appreciate the knowledgeable members/writers for taking the time to write. Thank you.

Robert J. Bryant  
16621 123rd Ave. SE  
Renton, WA 98058  
USA

[See Werner Stiffel's article, this issue.—ed.]



## Rear-steering recumbent bicycles (continued from page 7)

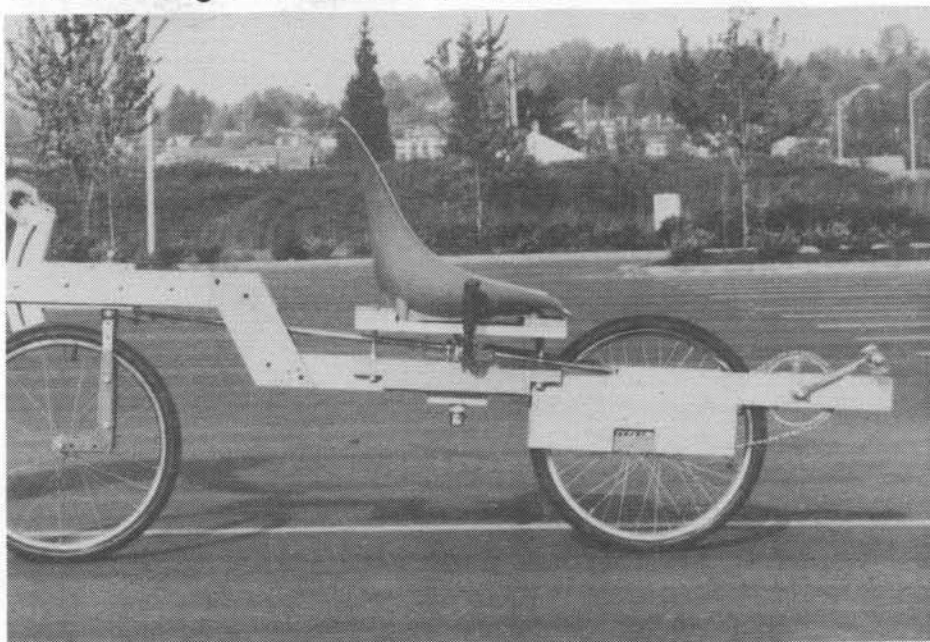

The MK IV adjustable rake RSRB

reduced to only 102 mm (4 in.) by the time the steered link had rotated 30 degrees. The idea was to have a large amount of trail for starting but have reduced trail for tight turns, thus minimizing the large lateral offsets that resulted from the large trails. Although the four-bar linkage concept was re-worked several times using different control linkages, it never worked as well as the single-pivot approach and was abandoned.

The MK-III variation returned to the single-pivot design but moved the pivot beneath the seat and used bearings that were rated for the large loads resulting from the cantilevered rear wheel. Laubach had used a pair of equal gear quadrants to reverse the steering control. Instead, I used a cam follower attached to the steering frame moving in a slot attached to the handlebars. While the length of the output link was fixed, the input-link length increased with handlebar angle resulting in a variable-ratio control linkage. MK III was used to evaluate trails of 762, 965 and 1170 mm (30, 38 and 46 in.) with control input/output ratios from 1.5:1 to 3:1. The best handling configuration used the 762 mm (30-in.) trail and an input/output ratio of 2:1. The point of diminishing return for trail had been reached, and larger amounts were impractical from the perspective of packaging.

The MK-IV variation fixed the trail at 762 mm (30 in.), the input/output ratio at

2:1 and allowed the steering-pivot rake to be adjusted +/- 21 degrees from vertical in 7-degree increments. The seat height was raised to 610 mm (24 in.), the seat back was upright and the B.B. height remained at 406 mm (16 in.) While the 762-mm (-30-in.)-trail, vertical-pivot MK III seemed to work acceptably when moving in a straight line, control seemed to be poor during tight low-speed turns. It was felt that steering-frame rake would improve this problem. Contrary to expectations, a rake angle that corresponded to a potential-energy peak when the wheels were centered, (that is the top bearing was moved back and the bottom bearing was moved forward), resulted in the best steering performance. While the full 21 degrees from vertical was best for turns, it was also a destabilizing influence during straight motion. A rotation of about 14 degrees from vertical (a 76-degree fork rake), was selected as a compromise between straight and turn performance. This configuration had the best low-speed stability of all the past or subsequent variations.

Inspired by the IHPVA activity at EXPO86, I decided to build a RSRB that could be raced at the IHPVSC. I took a brazing course in the spring of '87 and was ready to graduate from plywood, aluminum and pop-rivets to chrome-molybdenum tubing. At that time I had been almost exclusively riding an Avatar 2000 FSRB since the fall of '84. Although I had been quickly won over by its comfort,

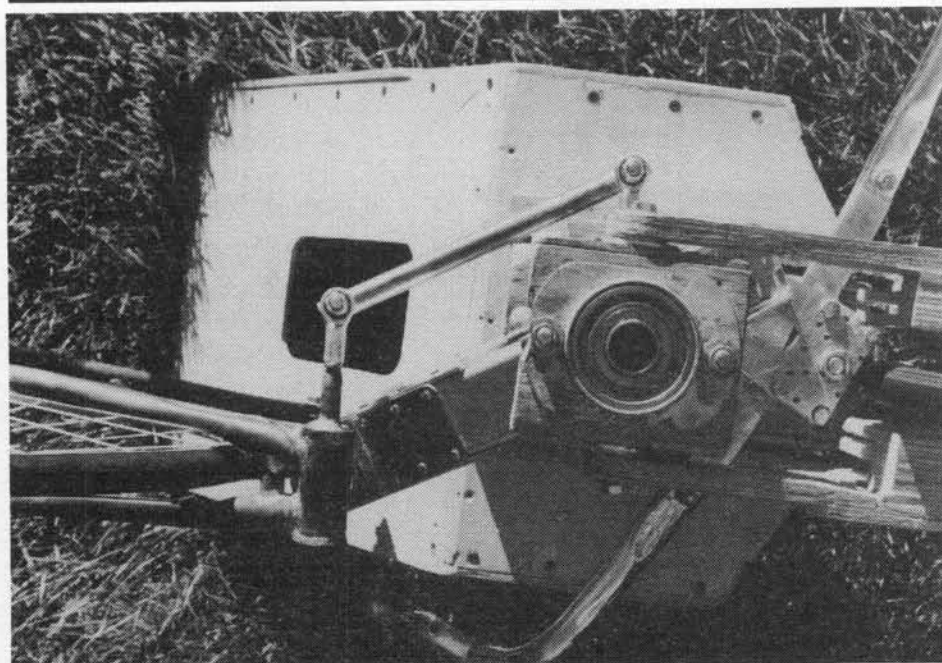

Parallelogram wheel-positioning linkage of MK VI RSRB (viewed from below)

design of the racing RSRB was finalized and christened the VelAero.

### The VelAero

The photographs show some of the technical details of the VelAero. The wheelbase is 1020 mm (40 in.), the seat height is 470 mm (18.5 in.), the B.B. height is 597 mm (23.5 in.), the steering angle is 15 degrees, the fork offset is 508 mm (20 in.) and the weight distribution is about 45/55 front/rear. The variable-ratio steering linkage has an input/output ratio of 3:1 when centered but is progressively reduced so that 47.4 degrees of handlebar rotation results in 30 degrees of steering-frame rotation. Weight is 15 kg (34 lb).

During the summer of 1988 the VelAero was ridden a total of over 800 km (500 miles) on trips of up to 80 km (50 miles) in length. The vehicle exhibited the unexpected phenomenon of the stability increasing significantly during acceleration. So, although the VelAero could not be balanced below 2-3 m/s (4-5 mph.) without significant weaving, starts were not difficult. The acceleration-related stability increase was also evident during sprints to speeds above 13 m/s (30 mph). During hill climbing the weaving occurred below 4 m/s (8 mph.), thereby restricting hill climbing to grades of 5 percent or less. By comparison the Avatar's CBS appears to be less than 0.5

I had been disappointed by its flat-course cruise speed which was about 1.5 m/s (3-mph.) slower than my conventional upright bicycle. My conclusion was that the Avatar sacrificed aerodynamic efficiency for comfort. The racing RSRB would therefore adopt a more aerodynamic posture.

Since the first four variations all employed a relatively upright posture and used 20 x 1.375 tires, I felt it would be prudent to build one last plywood-and-aluminum variation to evaluate the effects of a more-recumbent posture and larger-diameter wheels on stability. The MK-V variation used 700 x 25C tires, a seat height of 483 mm (19 in.), a seat-back angle of 45 degrees, and a B.B. height of 610 mm (24 in.) The fork rake was 75 degrees and the fork offset could be either 457 or 610 mm (18 or 24 in.), depending on whether the handlebars were before or behind the steering pivot. The 610 mm (24 in.) offset configuration proved the more stable. Although the MK V could still be started without assistance, the CBS had been raised and the low-speed stability reduced by the more extreme rider attitude. Since I was interested in the RSRB's speed potential and could start unassisted, I was not concerned by low-speed performance degradation. Because it was still unstable but rideable, the rider was forced to be vigilant when controlling the vehicle. Removal of one hand from the handlebars at speed could result in large-amplitude weaves that were very frightening. Although this problem was

not eliminated, it was greatly reduced by increasing the control input/output ratio from 2:1 to 3:1. (A hydraulic steering damper was added to the final racing version and it became possible to extract, drink from and replace a water bottle at speed with only very minor directional variations.) The final check was to evaluate the MK V's cruise speed at the local velodrome. The 1.5-m/s (3-mph.) speed deficit was recovered and the

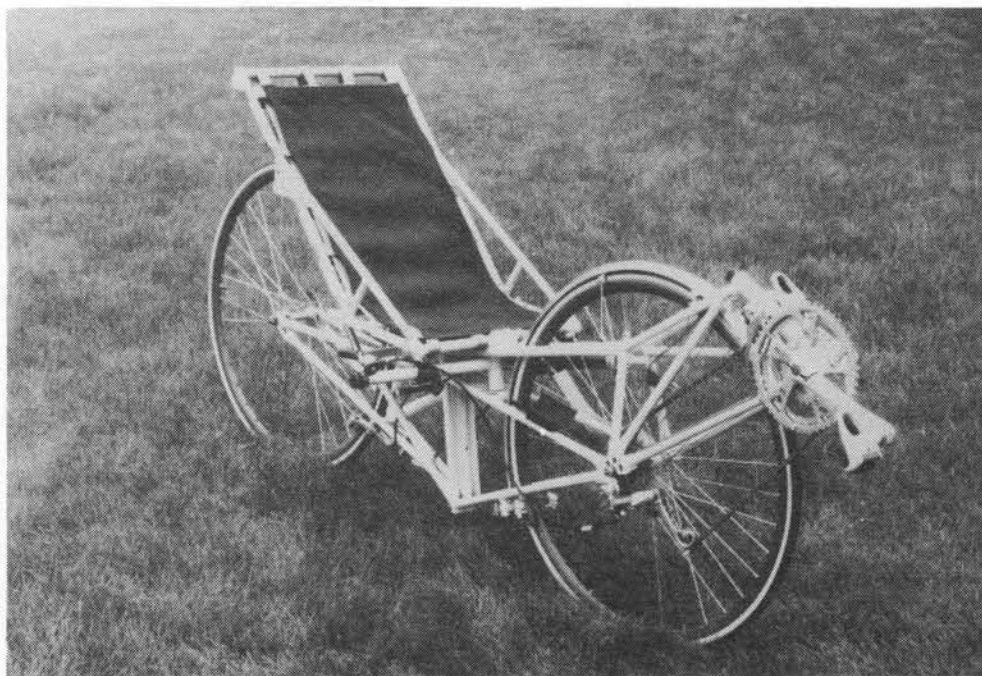

The VelAero

m/s (1 mph) on the flats and 2 m/s (3-4 mph) on steep hills.

### The stability effects of large positive trail

How does a large amount of positive trail improve rear-wheel steering stability? There appear to be at least three distinct mechanisms. Since the trail of these designs is correctly oriented, these mechanisms compensate for the adverse effects associated with reverse lean-steer.

One mechanism is that increases in the amount of positive trail result in reductions in the undesirable positive feedback that accompanies reverse lean-steer. Assume an RSB is leaned over. Gravity acting through the C.G. causes the vehicle to steer out of the turn as the C.G. falls. If the RSB is moving, the radial acceleration due to the turn generates a force that makes the turn even tighter. This is an undesirable positive-feedback effect. A measure of this positive feedback is the amount of radial acceleration force that is generated for a given amount of lateral C.G. displacement. For a given angular velocity the radial acceleration is proportional to  $1/R$ , where  $R$  is the radius of the turn measured to the C.G. For a given lateral C.G. displacement, the smaller the value of  $1/R$ , the smaller the positive-feedback force and the less unstable the configuration. Figure 1 plots  $1/R$  for various trail conditions given an RSB with a 1.2-m (48-in) wheelbase and a 55/45 weight distribution. The RSB was kept vertical, no lean angle was assumed, the C.G. displacement was 25 mm (1 in.) laterally and  $R$  was calculated as the distance from the C.G. and the intersections of the wheel center lines. Point 1 is a configuration similar to the desirable amount of lean-steer that might be exhibited by an FSB. Point 2 represents a reversal of the trail from Point 1. The amount of feedback is the same but it acts to increase the lean disturbance instead of decreasing it. The positive trail is greatly increased at Point 3, and the positive feedback is significantly reduced. While the lean-steer phenomenon is still reversed, the feedback value at Point 3 is closer to the desired value at Point 1 than is Point 2. Notice also the ever-diminishing returns for further increases in trail. Large increases in positive trail, then, reduce the destabilizing positive feedback that accompanies reverse lean-steer.

The second mechanism relates to the C.G. being displaced out of the turn when using large amounts of positive trail. This C.G. displacement partially compensates

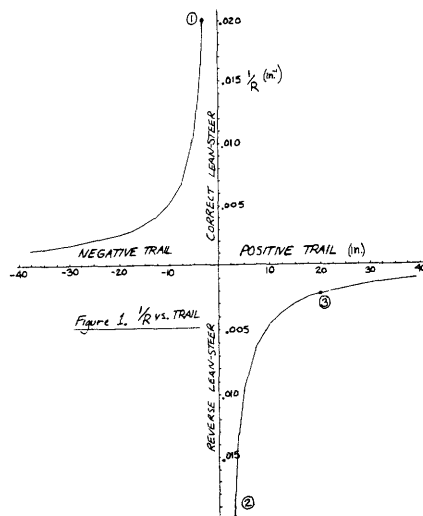

Figure 1.  $1/R$  versus trail

for lean disturbances. Refer to Figure 2, which represents the front view of an RSB.  $M$  is the mass and  $I$  is the mass moment of inertia about the C.G.,  $X$  is the absolute lateral displacement of the C.G. and  $relX$  is the relative displacement of the C.G. with respect to the massless outer frame. This outer frame represents the vehicle's ability to rotate about a ground axis passing through the contact patches of the tires. The absolute acceleration,  $ddX$ , can be determined as a function of the relative acceleration,  $ddrelX$ ,  $M$ ,  $I$  and  $H$ .

$$ddX = ddrelX * (I / (I + H^2 * M))$$

Notice that  $ddX$  is in the same direction as, but less than,  $ddrelX$ . From the accelerations it is inferred that the displacements  $X$  and  $relX$  are also in the same direction and similarly related. Assume the vehicle is disturbed to rotate about  $P$  so the C.G. is moved to the right.

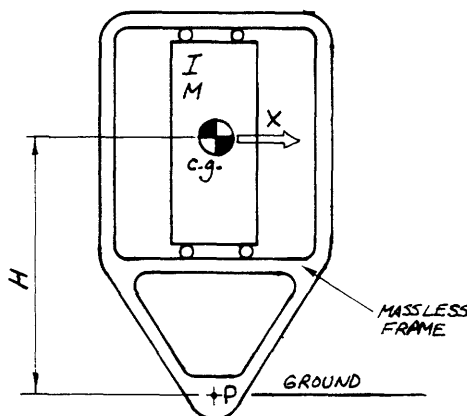

Figure 2. C.G. displacement model

To compensate, the rider steers the vehicle about a pivot point to the right of point  $P$ . The relative displacement, and consequently absolute displacements, are to the left, partially correcting for the initial disturbance. Even before the turn is underway the act of steering results in partial disturbance compensation. The radial acceleration associated with the turn completes the disturbance compensation. In a typical FSB configuration the static C.G. displacement associated with steering is towards the radius of the turn and increases the disturbance, but the trails and the magnitudes of the displacements are small. It is only with large amounts of trail that the absolute C.G. displacements become significant factors in improving stability.

A disturbance which leans the main frame over produces a couple composed of gravity acting through the C.G. and a resistive force perpendicular to the plane of the wheels due to tire contact. This couple tends to steer the RSB out of the turn, lower the C.G. and increase the lean disturbance. During acceleration, a second couple is developed composed of the tractive force acting at the front tire and the D'Alembert force acting through the C.G. which tends to reduce any steering angle. The acceleration couple opposes the lean-disturbance couple, reducing the undesirable positive-feedback effects of reverse lean steer. While the magnitude of the lean disturbance is not related to trail, the magnitude of the acceleration couple is directly related to trail, for a given steering angle. As a result acceleration stability is made significant by large amounts of positive trail, resulting in a RSRB which is easily started from rest.

One might expect that if acceleration stabilized the VelAero, then deceleration in the form of braking would reduce stability. This did not become a problem in practice because rear braking was used almost exclusively. Braking with the rear wheel also produced a couple that opposed the lean-disturbance couple.

### Conclusions

The construction and evaluation of the VelAero mark 10 years of experiments with RSRBs. While I was disappointed with its critical-balance-speed limitation of 2 m/s (5 mph.) on the flats and 4 m/s (8 mph.) on the hills, which prevented me from replacing the Avatar as my all-around bike, the VelAero exceeded its design objectives of being a recumbent that could be predictably controlled in a



VelAero at 30° steering angle

racing situation. Raising the seat height and rotating the rider forward, similar to the MK IV, would obviously improve the CBS, but at a price to performance that I feel is too high. (In fact, after the 1988 IHPVSC, Clive Buckler, of Polo Bike fame, constructed a "unicycle with trailer" RSRB similar to, but significantly more upright than, the MK IV, with about a 406 mm (16-in.) fork offset. The bicycle is reported to be extremely rideable.) Further fine tuning of the VelAero's trail and fork rake might allow the CBS to be lowered somewhat, but probably not enough to rival an FSRB. As a result, I feel the stability of the VelAero is close to the maximum for the long-trail approach to an RSRB, given the low rider posture. Unfortunately, the level of stability is not adequate for a general-purpose recumbent.

I feel my success with the VelAero should emphasize that the much-maligned concept of a RSRB holds the possibility of solving the recumbent packaging problem. While the VelAero is by no means the final solution, its performance is quite satisfactory for racing, and much better than what many "experts" said was possible. The important lesson relating to the beneficial effects of long trail is that the rear-steering stability problem requires solutions that will differ drastically from conventional front-steering geometries.

Long-distance human-powered flight seemed impossible until the correct technical breakthroughs were made. The rear-steering-recumbent design revolu-

tion is awaiting only the right breakthrough.

### References

1. L.H.Laiterman, Theory and Applications of Rear Steering in the Design of Man Powered Land Vehicles, B.S. Thesis, MIT, 1977.
2. S.H.Oliver and D.H.Berkebile, *Wheels and Wheeling*, the Smithsonian Cycle Collection (Washington: Smithsonian Institution Press, 1974) :36-37
3. R.Stuart, Rear Steering, Part Three, NWHPVA Newsletter (Vol. IV, No. 5, SEPT-Oct. 1988) :6

### Postscript

The question remained "How much could the critical balance speed of a low-slung RSRB be lowered using the long-trail approach?" An infinite trail configuration would result in the rear wheel translating laterally while remaining parallel to the front wheel. This should be the asymptotic-performance case for straight-line maneuvering.

With this in mind, the MK-V variation was recently modified to incorporate a near-parallelogram four-bar linkage to position the rear wheel. The linkage's actual instant center was no less than 7600 mm (300 in.) in front of the rear wheel's centerline. The rear wheel translated laterally 100 mm (4 in.) with a steering input of 25 degrees rotation.

Refer to the photo.

Because the MK-VI configuration could make only very minor steering corrections, testing was limited to essentially straight-line riding. Despite this limitation, in one-on-one tests between it and the VelAero, it became clear that the MK VI was easier to start and had a noticeably lower CBS than the VelAero. Since the MK VI lacked a speedometer, the actual CBS was not determined. Despite the improvement, the MK VI's low-speed performance was not as good as the Avatar's.

The actual implementation of this approach would require a two-phase steering system where the rear wheel would move parallel to the front wheel for small steering inputs and would be angled to the front wheel for larger inputs. The VelAero's low-speed performance could be noticeably improved, but at the expense of increased complexity.

Craig J. Cornelius  
22917 N.E. 20th Place  
Redmond, WA 98053  
USA

*Craig Cornelius is a mechanical engineer living in Redmond WA, who received his Ph.D. from the University of Wisconsin doing research on human-power generation. He is presently working on a moderate-wheelbase front-steering recumbent bicycle that includes a suspension and auxiliary arm power.*

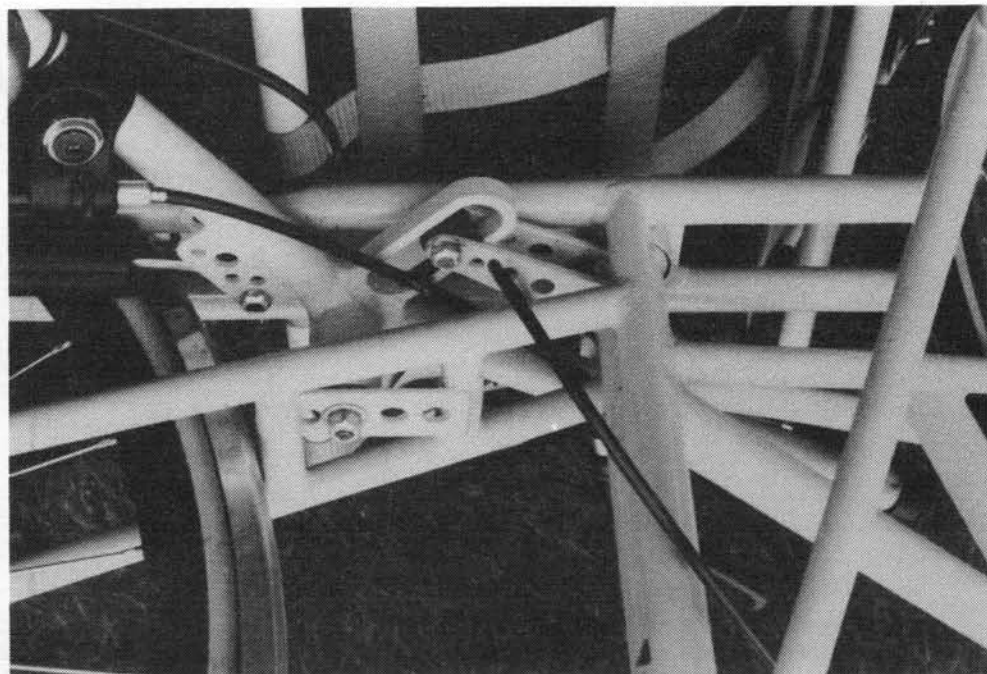

VelAero steering linkage and damper