

HUMAN POWER

THE TECHNICAL JOURNAL OF THE IHPVA

Vol. 7 No. 4

\$5.00

ISSUE NO. 25

Summer, 1989

The physiological limits of long-duration human power production—lessons learned from the Daedalus project

by Steven R. Bussolari and Ethan R. Nadel

INTRODUCTION

In 1985, a team of engineers at the Massachusetts Institute of Technology began a three-year research program with the goal of flying an advanced human-powered aircraft a distance of 119 kilometers from the Greek island of Crete. The project was named Daedalus, in celebration of the mythical Greek inventor who constructed wings of wax and feathers with which he flew from imprisonment some 3500 years ago. The proposed distance of the Daedalus flight was rather ambitious, considering the existing record for human-powered flight was 35 km, set in 1979 by Bryan Allen, flying the *Gossamer Albatross* across the English Channel. Preliminary estimates of the *Daedalus* aircraft performance indicated that the flight would last four to six hours. Because an aircraft engine must carry its own weight, its performance is often expressed as the ratio of mechanical power to weight and the estimates of power required to fly *Daedalus* ranged from 3.0 to 3.5 watts/kilogram. Before the Daedalus could be designed in detail, we needed an answer to the fundamental question: what are the limits of the human's capacity for long-duration power generation and how do those limits affect flight duration and range? The first part of this question is certainly not new, nor is it unique to human-powered flight, for it is applicable to any system that derives mechanical power from the human body.

The production of mechanical power by humans has long been the subject of study by a considerable number of

investigators. A good summary of the available data can be found in Whitt and Wilson (1982). We were particularly interested in the relationship between steady-state power produced and the maximum length of time that power could be sustained, but were disappointed that the methods employed in the various studies we reviewed varied widely, as did the results. In particular, the almost complete lack of data for durations in excess of one to two hours made it impossible to generate a quantitative model for the expected duration of the Daedalus flight. It is important to note, however, that measurements of this type are extremely difficult to perform, simply because each measurement must be carried out until the test subject is exhausted. The physiological preparation and psychological motivation of the test subject becomes an important experimental variable that is difficult to control in a repeatable fashion. A further limitation of the reviewed literature was the fact that important parameters, including test-subject body weight, level of training, and details of the measurement techniques are not uniformly reported. The result was that the existing data, while useful for establishing rough bounds on the problem, were of little help in establishing the engineering feasibility of the Daedalus flight.

THE PREDICTION OF LONG-DURATION POWER OUTPUT

The metabolic cost of flight. It is relatively easy to determine the metabolic cost to the pilot of maintaining a constant

mechanical power output. Potential energy is converted into mechanical work by the oxidation of stored fuels within the muscle itself (Nadel, 1985) with an efficiency that is generally accepted to be 24% (Åstrand and Rodahl, 1986). To put this in quantitative terms: for every 24 watts of mechanical power delivered at the pedals, 76 watts are generated as heat for a total metabolic cost of 100 watts. An alternative means of expressing the metabolic cost is by oxygen uptake in milliliters per minute per kilogram of body weight. Exercise physiologists refer to oxygen uptake as "aerobic power", in view of the assumption that the composition of the oxidized fuels remains constant for a given individual and therefore oxygen uptake is proportional to the metabolic power generated. In order to predict the maximal power output that we would expect from a pilot during a long-duration effort, we needed to determine experimentally whether humans reached their limits in the oxygen, fuel, or heat-transport systems at a sufficiently high power output on an ergometer. The maximum oxygen uptake, or maximum aerobic power of any individual is an objective index of that person's functional capacity to generate power. Middle-aged, healthy adults have a VO_{2max} of around 35 to 40 ml/min/kg and are able to increase this maximum by up to 20% within three months of beginning a moderately serious program of physical conditioning (Nadel, 1985). In elite endurance athletes, the maximum oxygen uptake (VO_{2max}) may be as high as

(continued on page 8)

Human Power

The Technical Journal of the
International Human-Powered
Vehicle Association

David Gordon Wilson, Editor
21 Winthrop Street
Winchester, MA 01890-2851, USA
(617) 729-2203 (home)
(617) 253-5121 (MIT)

Associate Editors

Theodor Schmidt, Europe
Rebackerweg 19
CH-4402 Frenkendorf
SWITZERLAND

Philip Thiel, Watercraft
4720 7th Avenue, NE
Seattle, WA 98105 USA

IHPVA

P.O. Box 51255
Indianapolis, IN 46251 USA
(317) 876-9478

Marti Daily President
Adam Englund Secretary
Bruce Rosenstiel Treasurer
Paul MacCready International
President

Doug Milliken VP Water
Glen Cole VP Land
VP Air

David Gordon Wilson Executive VP
Allan Abbott Board Members

Mike Burrows
Marti Daily
Peter Ernst
Chet Kyle

Gardner Martin
Matteo Martignoni
Dennis Taves

David Gordon Wilson

Human Power is published quarterly by the International Human-Powered Vehicle Association, Inc., a non-profit organization devoted to the study and application of human muscular potential to propel craft through the air, in the water and on land. Membership information is available by sending a self-addressed, stamped business-sized envelope to:

IHPVA
P.O. Box 51255
Indianapolis, IN 46251-0255 USA

Members may purchase additional copies of *Human Power* for \$3.50 each. Nonmembers may purchase issues for \$5.00 per copy.

Material in *Human Power* is copyrighted by the IHPVA. Unless copyrighted by the author(s), complete articles or representative excerpts may be published elsewhere if full credit to the author(s) and the IHPVA is prominently given. We welcome contributions of articles, notes, reviews and letters sent to any of the editors. Contributors' guidelines are available from David Wilson.

Special thanks to the authors, Marti Daily and Kim Griesemer, without whom this issue would not have been possible.

Editorials

Engineering standards

Three recent events emphasized the desirability of adhering to engineering standards in most cases and of departing from them in others.

The first was a series of accidents to people in truck-mounted "cherry-pickers"—person-carrying baskets on articulated arms—in which several telephone line repairers have been suddenly dropped to the ground, giving them serious injuries in many cases. I was asked to serve as an "expert witness" in one of these cases, so that I had access to some of the design data. The bucket is held up by several strong steel stranded cables going over pulleys or sheaves. The engineering standard for the minimum diameter of sheaves for wire rope is 72 times the rope diameter. The designer of the cherry-picker had used about a tenth of this safe diameter. Consequently it was simply a matter of time before every rope failed in fatigue, no matter how "strong" it was. The stress induced in the rope by bending it around a small pulley was far higher than the stress needed to hold up the basket. It might have been preferable, in fact, to have used much-smaller cables operating at higher mean stresses with much-lower bending stresses around the pulleys. It would also have been preferable to have used either much-larger sheaves, or to have used chains instead of wire rope.

This is an engineering standard that is also ignored by most manufacturers of bicycle hand brakes and derailleur shifters. Although I try to buy the most supple cables available, to keep them well greased and to avoid kinks, I know that my cables will fail every so often because of the appallingly sharp corners and small radii around which bicycle cables are required to operate. The failure of a gear cable is irritating but not life-threatening. A brake-cable failure is potentially very serious. Here is an engineering standard that we should urge bicycle-component designers to adhere to as soon as possible. (Incidentally, the hydraulic brakes of my car—perhaps I should say my ex-car—have just suffered a virtually total failure as I was braking for a red light. There is an engineering standard to ensure that one could never lose braking on more than two wheels out of four, but the designer apparently did not conform closely enough to this. Bicycle designers are not alone in their cavalier avoidance of good engineering practice.)

A second example, this time of less-virtuous standards, was revealed in the introduction to a delightful book about the audacious transatlantic steamers designed in Britain in the last century by Isambard Kingdom Brunel: "The Iron Ship". The Royal Navy had been so successful in earlier times that engineering standards had been issued to fix various ratios, such as of beam to hull length, at those of the best ships of the past. But technology advances, and at the end of the eighteenth century American naval and commercial ships, unhampered by such archaic regulations, could overhaul British ships in almost all conditions. (The iron steamships that Brunel designed, without recourse to crippling rules, helped to restore some degree of international supremacy to British powered vessels. Sailing vessels remained in the second rank behind the US.)

My third example is more related to HPVs, and is of what is merely a de-facto standard: that of using half-inch (13-mm) chain for transmissions. Most HPVs have recumbent riders and very long, and therefore heavy, chains. There was an unsuccessful move in the early years of this century to introduce smaller chains for bicycle drives, chains which would have been fully adequate for the duty.

In This Issue—

<i>The physiological limits of long-duration human power production—lessons learned from the Daedalus project</i>	1
by Steven R. Bussolari and Ethan R. Nadel	
Editorials by David Gordon Wilson	2
Letters to the editor	3
<i>Some ideas used on Hydro-ped—</i>	5
<i>a hydrofoil pedal boat</i>	
by Sid Shutt	
<i>The baking of the Bean</i>	11
by Miles Kingsbury	
Reviews	15

Designers of HP aircraft have generally used "chain" of conventional pitch but could not afford the weight of regular steel roller chain, and have frequently employed a Berg lightweight drive consisting of two fine steel cables bridged by nylon molded-on cylinders, spaced and sized to resemble the rollers of a regular chain. Berg tried to produce versions that would work on derailleurs, but gave up. MIT's Daedalus group found the Berg drive over the long spans required for HPAs unreliable enough to develop a gear drive for its record-breaking long-distance aircraft. Alec Brooks and Allan Abbott reintroduced small-pitch (I believe of 3/8", 10-mm) chain for the Flying Fish, and their lead is being followed by other builders of HPBs and HPVs in general. May the designers of derailleurs develop gear change systems to use this smaller, lighter and probably more-efficient size of chain.

Aluminum forks?

In the March issue of *Bicycle Guide*, Doug Roosa reviews the new generation of aluminum bicycle forks coming on to the market. Charles Brown sent me a copy, stated his concern for the integrity of these components, and suggested that I write a letter to warn potential users about them. I confess that I do not quite have the conviction to do so. I'm taking this easy way out.

The problem is this. Almost all the aluminum components of my bicycles, however robust their appearance, have at one time or another failed without any warning. Three handlebars, a handlebar stem, a crank, wheelhubs and rims are among this group. They did not get flexible and creak, as steel components usually do before failing. They broke as if explosive had been inserted somewhere. I have survived these failures more through luck than skill. If one were riding a diamond-frame "regular" bike, no amount of luck could save one from a high probability of injury if a front fork failed in this manner. One of the major advantages of recumbents is that component failure, even of a front fork, is far less likely to result in serious injury than if one were poised head first over the front wheel.

Roosa includes a warning: "Aluminum forks should be treated as high-performance items. That includes regular inspections for any signs of fatigue at the fork crown and dropouts". But my experience of aluminum components is

that they do not show any evidence beforehand of incipient failure.

The advertisements for aluminum forks and frames are, however, reassuring. They have been rigorously tested for the equivalent of several bicycle lifetimes without failure. I am an engineer, and I should not stand in the way of new technology. It wasn't long ago that steam boilers with pressures under one atmosphere were exploding with sad regularity, killing many. Nowadays we have steam generators running at hundreds of atmospheres and high temperatures that have run safely for decades.

So let us hope that the fork designers and developers have done their work well. As far as I am concerned, I would be happy to have one on my recumbent, but I do not have the pioneering passion to want one on any "regular" bike anyone in my family rides.

(continued on page 10)

Letters to the editor

In defence of the Moulton—the author's response

I cannot imagine the reason for Derek Roberts' indignation [over our article in 7/1/88/1]. I have shown only the results of measurements following an internationally standardized method. On most surfaces the AM7 was the best commercially available HPV. What more does he want?

The difference between the roadster and the AM7 is small, but the AM7 has the great advantage of a much lower rolling resistance. The vehicle weights were noted in the vehicle descriptions. The AM7 is my own, used daily for commuting, equipped with a rear carrier, generator and lights, a Citadel lock and some modified components, so that the bare mass of 10.9 kg was increased to a higher figure to include these needed extras.

I agree with Roberts' personal opinion on the AM7: that he prefers it to all his other bicycles. I felt the same way about his mine, too. Just lately I have built my own bicycle with my own design of suspension.

The measurements show that on all surfaces the vibrational stress at the saddle of the AM7 is much higher than for the hand-arm system. I do not know the exact reason but I guess that the

spring rate of the rear suspension is too high and/or that the frequency response of the rubber leads to a stiffer spring rate for higher frequencies. I may be wrong in assuming an effect of the internal damping of the rubber as the reason for the bad results (relative to the results for the front suspension).

Swinging of the rear suspension (and the front suspension, too) on the AM can be ascertained when riding on smooth surfaces. It would be better—and it can be almost realized—if pedalling had no effect on the suspension.

The aim of my article was to show how very high the vibrational stress on bicyclists can be. I wanted to encourage discussion of the quality of cycle tracks in Germany, and I wanted to encourage the readers of *Human Power* to take suspension into consideration when designing an HPV.

I did not want to assert that the AM7 had a deficient suspension, but the results of our measurements show that a more comfortable bicycle suspension is needed for some conditions. First experiments indicate that the goal can be reached.

Rainer Pivitt
Fachbereich 8
Physics, Universitat Oldenburg
PB 2503
D2900 Oldenburg, WEST GERMANY

Hydrogen-air fuel-cell-powered vehicles

I am writing to ask for information, developments, and suppliers of equipment for the development of a hydrogen-air fuel-cell-powered vehicle based on existing HPV technology. Most hydrogen-powered vehicles to date have used conventional internal-combustion engines in their design, which simply changes one fuel for the other within a system plagued by high Carnot losses and inefficient operation. . . Utilizing high-pressure hydrogen to several-hundred atmospheres in a Kevlar- or carbon-fibre tank for light weight, a small fuel cell from United Technologies, and a high-quality electric motor as used in the Sunracer would illustrate the practical and immediate potential of hydrogen as a fuel for transport. The hydrogen would be derived from photovoltaic cells, or from a wind generator, electrolyzing water at home and compressing hydrogen into a spare tank in the home. . . The only byproduct of the fuel cell is pure water. Surplus hydrogen could be stored at

home to be used for cooking, heating, etc.

I await your reply. I have further information to share with IHPVA members should (they) request it.

Gregory Spry
P.O. Box 83876
Fairbanks, Alaska 99708 USA

News from Japan

I organized a small lecture about solar power and human power on March 4, 1989 in Yokohama. The lecturer was a Mr. Peter Ernst, of Future Bike, Switzerland. He talked to us about HPVs, the HPA Daedalus, and the Tour de Sol. Over sixty people came to the lecture.

Toshio Kataoka
914-6 Mamedo, Kohoku
Yokohama, Kanagawa, JAPAN 222

(Toshio Kataoka gave us several other pieces of news that I sent on to Jean Seay for HPV News—we are grateful for his contributions).

Arthur Baxter comments on his article

It has improved my ego to have a letter from the USA arising from my article. As I have not done any more practical work on recumbents since 1939, I am sorry that I have no basis for an update. The paper you sent [on the history of recumbents, from an IHPVA Scientific Symposium] is of great interest to me, as I had not known of the many activities described in it. Perhaps some comments on these, and on non-circular pedal motion would be of interest?

I agree that for general use the seat of a bicycle or tricycle should not be lower than those of a normal automobile; otherwise the three "D"s—danger, dirt and derision—are unavoidable. You may now question why my '39 trike had the seat a mere six inches or so (150 mm) above ground level. This was worked out as follows. Minimum frontal area and short wheelbase were considered to be essential. These could not be combined in a two-wheeler. A tricycle had to be as low as possible to prevent capsize on bends (the rider cannot lean in to counteract this on a recumbent, as he can on a normal tricycle). In the '39 trike, first drive, (HP 7/3/23) the pedals are level with the seat only at the lowest point of their travel, and 13" (330mm) higher at the top point. This is why the rotary drive was so tiring, the feet being above the hips most of the

time. The pendulum motion (HP 7/3/24) was much better for both comfort and reduction of fatigue. An attractive feature was the ability to freewheel with the feet opposite each other on each side of the machine.

In the Avatar [and many similar recumbents] the relative positions of pedals and feet are very different to the above, and I can well appreciate that in this case, rotary pedalling is quite satisfactory. I am surprised that you find the [LWR] Avatar 2000 no harder to push than the shorter [SWR] Avatar 1000. About the only thing that keen cyclists here are agreed about is that longer bikes are harder to ride up hills. Also the [LWR] would seem to be less safe in accidents, when the experience might be like sliding down a staircase handrail with a knob at the bottom (long top tube and steering-head top). The escape route from a [SWR] seems to be much less hazardous! The long bike will take up more storage space, but then you have more room in the States than we have here!

Even if pendulum crank motion is not needed on the [LWR] Avatar, it may be interesting to consider why I did not have such difficulty with this type of motion as you and your friends have had [as described in the paper mentioned]. The configuration of the pendulum on my trike was such that, when one of the pendulum cranks, via its connecting rod, pulled its rotating crank to top dead centre, the other rotating crank had, by a few degrees, passed bottom dead centre (see sketch). Even so, I had to ease off the foot pressure towards the end of travel so that the momentum of the cranks-chainwheel assembly helped past the point of possible "lock up". One does this in normal rotary pedalling. [This type of system is called a "quick-return motion"—ed].

[The following comment is on tire construction]. When the first pair of (heavy Dunlop) tires wore out, . . . I ordered a low-price pair of hand-made Constrictor tires. I was horrified when I saw them. It looked as if there was not enough rubber on them to last 100 miles, and as if they would puncture very easily. But what a revelation! Much faster running, and all the smaller bumps completely absorbed, their flexibility saving them from rapid wear and punctures. Since then I have believed that hard narrow tires are a hindrance to progress except on perfectly smooth surfaces, and where are they? The power

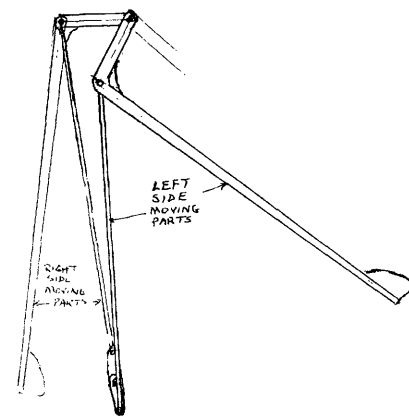

Pendulum configuration

from one's legs has to be shared between going forward and going up and down due to bumps, so the less there is of the latter the more is left for forward progress. The rolling drag of fatter flexible tires is a small loss for a large gain.

A. D. Baxter
74 Southgate
Scarborough, YO12 4NB
ENGLAND

Rear suspension pivot point

In HP 7/3/89 Robert L. Price wrote an article on HPV steering and suspension design. What he wrote about Fig. 19 can be interpreted as that the best position for the pivot of a rear wing-arm is in, or a little above, the line of the chain. I have constructed six recumbents with rear suspension, and by the old-fashioned method of trial and error I found that the best position for the pivot is 20-30mm below the chainline. Meanwhile my friend Wilfried Schmidt has worked theoretically on this point and has found the same result. I'm sending the article and something I wrote about suspension. I'm afraid that the two are available only in German.

Werner Stiffel
Hubschstr. 23 D 7500
Karlsruhe, W. Germany

(I'll copy these and send them within the US for \$2.00. I'm embarrassed to have had an excellent how-to-build article by Werner Stiffel on one of his suspension recumbents, translated by Theo Schmidt, but have lost the diskette. I will ask someone to transcribe it again so that we can have it in the next issue—ed.).

(continued on page 16)

Some ideas used on Hydro-ped—a hydrofoil pedal boat

by Sid Shutt

ABSTRACT

The basic ideas used to design Hydro-ped, a human-powered hydrofoil boat, are outlined. A design configuration using these ideas is described that gives easy takeoffs, stable operation in all axes, competitive speeds, and reliable performance with available power.

INTRODUCTION

In 1861 Thomas Moy, an Englishman, investigated airplane wings by testing them in water where he was able to measure forces more accurately than in air. He reported that at moderate speeds he was lifted "quite out of the water." This event is reported to be the first invention of hydrofoils and the first report of hydrofoils in operation. Since that time a number of inventors have used hydrofoils for various water vehicles, including E. Forlanini (1906), A. Croco (1907), Alexander Graham Bell (1918), V. Grunberg (1934), Christopher Hook (1967) and others. All of these vehicles used powerful engines. Hydrofoils were also used successfully on sailboats starting with J.G. Baker in 1950 followed by a number of craft, including my own, beginning in 1970. It became apparent to me in the late 1970s that a human-powered boat could be made to operate on hydrofoils and my 1980 design looked interesting enough to build. It was built in 1983, but was not operated on hydrofoils until the summer of 1985. In the meantime Allan Abbott and Alec

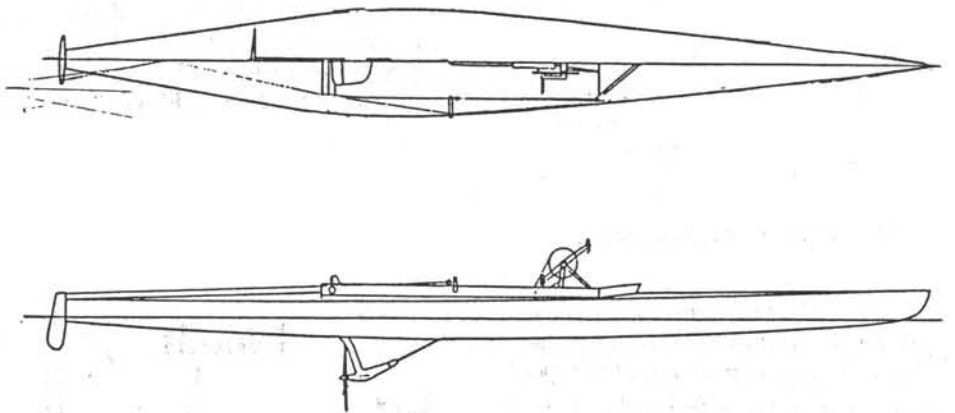

Figure 2. Hydro-ped—displacement configuration

Brooks operated their successful hydrofoil vehicle, the Flying Fish, as reported in the 1984 winter issue of *Human Power*.

This report is a summary of the basic ideas used to design the hydrofoil pedal boat that I call the Hydro-ped. The details of analysis, design, construction, performance calculations, and test results are left for future reports.

GENERAL DESCRIPTION OF VEHICLE

A single displacement hull similar to an Olympic smooth-water kayak is driven with a 0.36m-diameter (14-inch) propeller; the operator uses conventional bicycle pedals while in a sitting recumbent position. Without the hydrofoil attachments the boat operates as a displacement kayak, but driven with leg muscles and

steered with hands. With the hydrofoils attached the vehicle is converted to a competitive speedster as shown in Figure 1.

The Hydro-ped was designed to use specific ideas that are related to easy takeoff, reduced drag after takeoff at good speed, stable operation in all axes, and a light structure that allows sufficient strength with available materials. The boat design that implements the ideas to be given is shown in Figure 2 without hydrofoils. Its drag characteristic is shown in Figure 3.

Hydrofoil attachments are connected to the boat shown in Figure 2 to become a competitive human-powered hydrofoil vehicle as shown in Figure 4. Its drag characteristics before takeoff, at takeoff, and after takeoff are shown in Figure 5.

BASIC IDEAS

The basic ideas are primarily related to the three modes of operation: before takeoff, at takeoff, and after takeoff.

Before takeoff

Before takeoff there are several requirements that must be implemented to make takeoffs practical for me; these are:

1. good speed at comfortable power;
2. low weight;
3. low induced drag; and
4. large hydrofoil area.

These are interrelated but will be discussed separately.

1. Good speed before takeoff.

I desired to take off with an input power of 200 watts which I could deliver comfortably. A speed of 3.3 m/sec could



Figure 1. Hydro-ped in operation

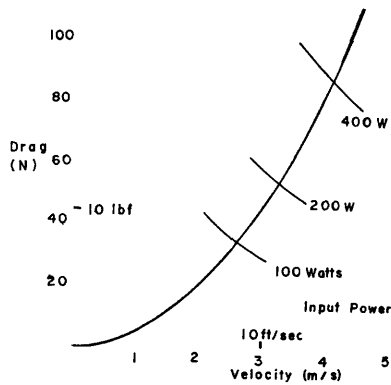

Figure 3. Displacement performance

be made with this power using a kayak-type displacement hull. The additional drag of the hydrofoils reduced the speed to 3.0 m/sec at the same input power, and this speed was selected for takeoff.

2. *Light weight.*

Light weight is important in reducing the hull displacement for low hull drag, in producing a smaller load the hydrofoils must lift, and less mass to accelerate. The Hydro-ped I including hydrofoils weighs 20 kg.

3. *Low induced drag.*

Below takeoff speeds the hydrofoils need not produce lift, so their lift coefficients are made low resulting in low induced drag. In displacement operation the main hydrofoil is set to have a lift

coefficient C_L of 0.35, an aspect ratio, A , of 33, and a hydrofoil shape and depth coefficient, k , of 2.6 giving an induced drag coefficient, $C_i = C_L^2 / (A \cdot k)$, of 0.0015, an acceptably small value.

Before takeoff the bow hydrofoil load is its own weight, a force of 0.4N. Just before takeoff its induced drag coefficient is less than 0.0002. The additional drag of

the hydrofoils without significant induced drag is then small enough to permit good speed before takeoff.

4. *Large hydrofoil area for takeoff.*

The load that the main hydrofoil must lift, L , is 780N. A lift coefficient, C_L , of 0.90 at takeoff is realistic. The main lifting hydrofoil area at takeoff was made to be 0.21 sq. m. These parameters

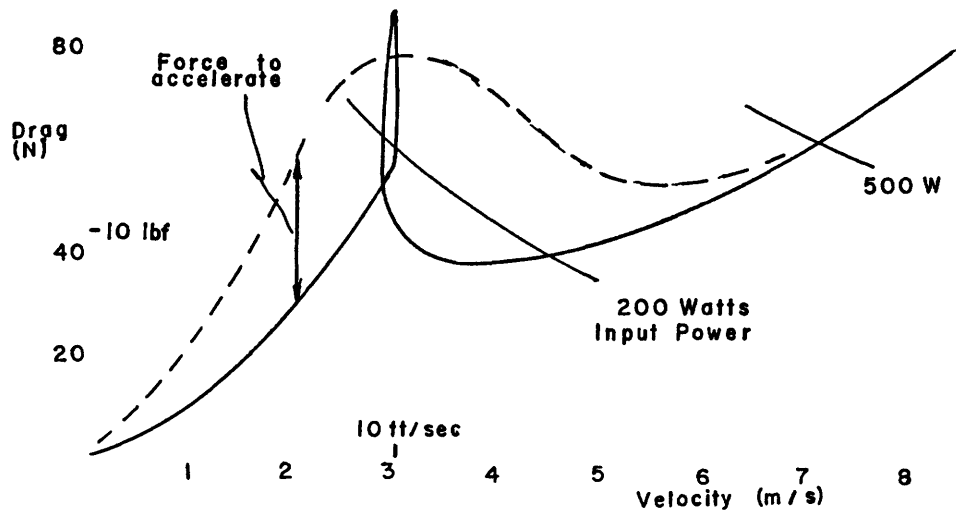

Figure 5. Hydrofoil performance

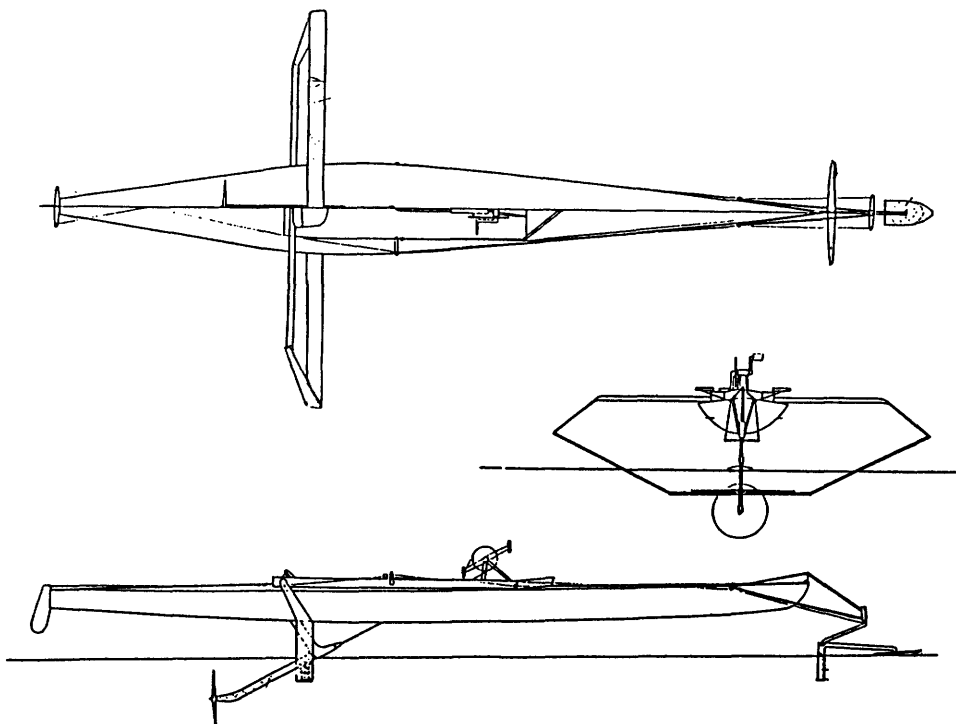

Figure 4. Hydro-ped—hydrofoil configuration

produce ample lift when takeoff is initiated at a velocity, v , of 3 m/s. The relationship of these parameters is $L = 530 \cdot C_L \cdot A \cdot v^2$.

At takeoff

At takeoff several ideas are used to give deliberate, quick, and easy takeoffs to lift the hull out of the water using the parameters established before takeoff.

These are:

1. bow raised to increase main hydrofoil lift;
 2. momentum to overcome large takeoff drag; and
 3. reduced hull drag.
1. *Bow raised to increase main hydrofoil lift.*

At a takeoff speed of 3.0 m/s the bow of the boat is raised by pulling the bow hydrofoil down relative to the hull bow. The bow hydrofoil then produces a lift of 112N which lifts the hull bow about 0.4m above the water surface. This pitches the boat up by 6 degrees increasing the main hydrofoil lift coefficient from 0.35 to 0.91. The load the main hydrofoil is able to lift at these conditions is then 912N.

Since 780N is needed to support the hull out of the water, a force of 132N is

available to accelerate the boat mass vertically. The initial upward acceleration at liftoff is greater than 1.0 m/s^2 . In less than a second the hull is out of the water.

2. *Momentum to overcome large takeoff drag.*

The lift coefficient at takeoff increases from 0.35 to 0.91 giving an induced drag coefficient that increases from 0.0015 to 0.01 and a profile lift coefficient that increases from 0.010 to 0.018. The bow-hydrofoil drag coefficient similarly increases from 0.012 to 0.04. The increased profile, induced, and wave drag of the bow hydrofoil and the main hydrofoil added to the hull drag at initiation of liftoff is considerably larger than can be maintained at 3m/s at an input of 200 watts. But, because the pitch-up occurs rapidly, the momentum of the vehicle adds the needed additional forward force to overcome the increased drag at liftoff to get the hull out of the water before it slows significantly. Once the hull leaves the water the total drag is smaller than it was before takeoff was initiated.

3. *Reduction of hull drag.*

The hydrofoils lift the hull out of the water and the hull drag is reduced to air drag. And, of course, this is the main idea of the hydrofoil vehicle.

After takeoff

After takeoff some ideas are used to adjust the parameters to minimize input power over a broad speed range, go fast, be stable in all axes, and allow a light-weight structure that has sufficient strength using available materials. These ideas are listed:

1. reduced drag of hydrofoils;
2. height and main-hydrofoil-area control;
3. force balance;
4. bow-hydrofoil operation;
5. roll stability; and
6. structural considerations.

1. *Reduced drag of hydrofoils.*

As the hull increases in height above the water surface the hydrofoil angle of attack decreases, lift coefficient decreases, and the main hydrofoil area decreases. Profile and induced-drag coefficients are decreased as the boat accelerates to steady-state velocity. At top speed the main hydrofoil area is near 0.06 sq.m , a reduction of 3.5 from the liftoff area.

2. *Height and main-hydrofoil-area control.*

The bow height above the water surface is set to match conditions of operation. If a fast sprint is desired a high setting is made giving small main-hydrofoil area for high speed. If duration

is desired a low setting is used giving a larger area. The height can be adjusted to give the main hydrofoil area that will minimize the input power at a given velocity.

3. *Automatic force balancing.*

Operating at above takeoff speed the hydrofoil lift forces equal the weight of the craft. If the boat decreases in speed the hydrofoil lift is less causing the hull center of gravity to move down. Since the bow foil holds the bow at nearly constant height, the main hydrofoil angle of attack and its area increase until sufficient lift is generated to balance the boat weight. If the boat increases in speed the CG lifts up decreasing the area and angle of attack until a new balance is reached. This action is constantly occurring maintaining the hull at an average preset height.

4. *Bow-hydrofoil operation.*

The bow hydrofoil has a similar action as the main foil in maintaining a force balance. A horizontal hydrofoil of $0.03 \text{ square meter}$ area is attached to the bottom of a vertical fin that is also the rudder. The top of the vertical fin is attached to a horizontal forward arm. At the forward end of the horizontal arm is a planing surface that rides on the average water surface. As the load on the bow foil is increased the hydrofoil is pushed down, causing its angle of attack to increase resulting in more lift until the generated lift balances the load. This configuration is very stable with a good response to input disturbances. Detailed control analysis of this design will show its stable operation with lead compensation giving a well damped transient response to input-water-surface irregularities. I have found this design works well on my hydrofoil sailboats where stable, fast response to rough conditions is absolutely essential.

This design has been patented by me and used elsewhere. The first time my Hydro-ped and Allan Abbott's and Alec Brook's Flying Fish were together, in the spring of 1988, the Flying Fish had its trailing-surface-sensor, elevator-linked bow-hydrofoil assembly. At the 1988 IHSPC at Visalia they had changed to my configuration for their front hydrofoil.

5. *Roll stability.*

The surface-piercing main hydrofoils not only give variable hydrofoil area, but also prevent the high center of mass from tipping in roll. The dihedral angle of the hydrofoil at the water surface also produces a stable bank in turns.

6. *Main-hydrofoil structure.*

Eighty-five percent of the load when

on the hydrofoils is carried by the main hydrofoil. Since ends of the main hydrofoil extend above the water surface the tips are connected to an aluminum tube that carries much of the load in both bending and torsion without adding much drag or weight. The hydrofoil center is supported by the drive strut. This structure allows hydrofoil shapes to be used that are determined by hydrodynamic rather than by structural considerations for the under-water portion.

CONCLUSION

Most of the ideas used in my hydrofoil boat configuration have been around for a while, and some are new, but I do believe the total combination of all the ideas applied to the Hydro-ped creates a new and unique water vehicle that allows me, with my limited energy, to enjoy operating it on the hydrofoils as it is intended. It is hoped that some of these ideas will help stimulate others to design and build water vehicles to compete in the International Human-Powered Speed Championships in future years.

REFERENCES

- Richard Von Mises, *Theory of Flight*, 1945 Dover Publications, Inc., New York, NY.
- Ira H. Abbott and Albert E. Von Doenhoff, *Theory of Wing Sections*, 1959, Dover Publications, Inc., New York, NY.
- Sighard F. Hoerner, *Fluid-Dynamic Drag*, 1965, published by the author, P.O. Box 342, Brick Town, NJ 08723.
- C.A. Machaj, *Sailing Theory and Practice*, 1964, Dodd, Mead, & Co., New York.
- Lindsay Lord, *Naval Architecture of Planing Hulls*, 1963, Cornell Maritime Press, Inc., Cambridge, MD.
- John K. Vennard, *Elementary Fluid Mechanics*, 2nd Ed., 1947, John Wiley and Sons, Inc.
- S. Timoshenko and D.H. Young, *Elements of Strength of Materials*, 5th Ed., 1968, D. Van Nostrand Co., Inc., New Jersey.

(Sid Shutt is an electrical engineer and a registered professional engineer in mechanical engineering and control-systems engineering in California. He operates an engineering company specializing in new-product development.—ed.)

Sidney G. Shutt
612 Briarwood Dr.
Brea, CA 92621 USA

□

Lessons from Daedalus

(continued from page 1)

70 to 80 ml/min/kg (Åstrand and Rodahl, 1986) and they are able to maintain energy production without the production of excess lactic acid during exercise that demands up to 80% of VO_{2max} . We hypothesized that these athletes, who have induced adaptations to physical activity in both the oxygen-delivery and oxygen-acceptance systems, would be capable of sustaining, for four to six hours, a power level that produced oxygen uptakes of 70% of their VO_{2max} . We chose the figure of 70% arbitrarily to provide a margin of safety from the excess-lactic-acid threshold.

Measurement of oxygen uptake. We began a series of laboratory measurements of oxygen uptake and mechanical power production as part of a screening process in order to identify a pool of suitable pilot-athletes. Our plan was to select those athletes who could meet the criterion of a mechanical power production of 3.5 watt/kg at 70% of their measured VO_{2max} and then verify our hypothesis that they would be capable of producing that level of power for a period of time comparable to that anticipated for the Daedalus flight. Announcements of the search for pilots for the Daedalus Project produced 300 applications, a number of these from Olympic-caliber athletes. We invited 26 (24 men and 2 women) to be tested, all of them either cyclists or triathletes. We had determined that athletes who have been training on the bicycle would be expected to be the most efficient at power production for the Daedalus aircraft because they had been using the specific muscle groups for cycling in their training regimes.

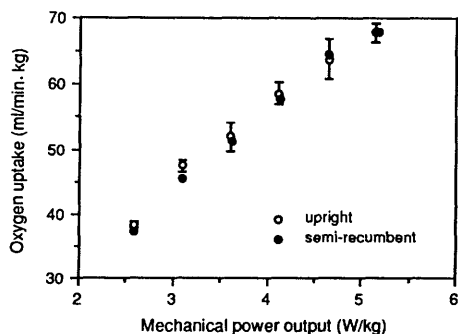

Figure 1. Typical results of a test for maximum oxygen uptake on a semi-recumbent cycle ergometer.

The test for maximum oxygen uptake was given on a semi-recumbent cycle ergometer with which the athlete's mechanical power output could be precisely measured. During the test, the athlete breathed through a low-resistance, two-way valve, into an apparatus with which we could measure the mass flow rate of respiration and the amount of oxygen and carbon dioxide in the expired air. We used an incremental load paradigm for the measurement of maximum oxygen uptake (Åstrand and Rodahl, 1986). Figure 1 shows the results for a typical ergometer test. The relation between oxygen uptake and mechanical power output is linear except for the final value, which diverges from this linear relationship due to the fact that, at this high mechanical power output, a significant fraction of the power is produced anaerobically. This anaerobic power fraction cannot be accounted for by oxygen uptake; therefore, as we increase the demand for mechanical power, we do not see a corresponding rise in oxygen uptake. When a straight line is fitted to the data (without including the highest value which includes the anaerobic component), we obtain the equation: oxygen uptake = $a + b \times$ (mechanical power output), with the value of a representing the oxygen uptake contribution to metabolic processes independent of mechanical power output, and with the value of b representing the ratio of oxygen uptake to power output. We determined the maximum aerobic mechanical power by substituting the maximum oxygen uptake measured for the athlete into this equation. Calculation of the mechanical power output at 70% of VO_{2max} is accomplished by substituting oxygen uptake at 70% of the measured maximum into the equation and solving for mechanical power.

THE EFFICIENCY OF MECHANICAL POWER PRODUCTION

Definition of efficiency. The mechanical efficiency of a given athlete may be estimated from the slope of the linear relationship between oxygen uptake and mechanical power production if one makes suitable and consistent assumptions about the composition of the compounds oxidized in the metabolic processes. In particular, the ratio of glucose (sugar) to lipid (fat) "burned" is quite important and differs among individuals. Remarkably, the mechanical efficiencies among the 25 athletes tested ranged between 18.0 and 33.7%, indicat-

ing a maximum oxygen uptake alone is not a sufficient measure of performance when predicting mechanical power output. As Figure 2 illustrates, two athletes with nearly identical maximum oxygen uptakes can have widely different efficiencies, 20.1 and 26.6% in the example shown. At 70% of maximum oxygen uptake, the values for mechanical power production are 3.31 and 4.21 W/kg, which means that the more efficient of the two is able to generate 27% more mechanical power at this level of uptake. Another way of looking at the difference between the two, which is applicable to cases where the task demands a constant power output (human-powered flight is a good example), is that the oxygen uptake necessary to generate a power output of 3.5 W/kg is 74% of maximum in the less-efficient athlete and only 59% of maximum in the more-efficient athlete. The more-efficient athlete will therefore be operating further from anaerobic limits and would thus be expected to have greater endurance.

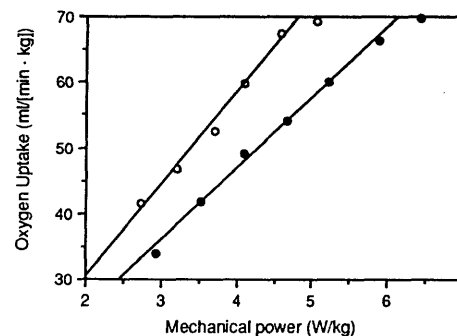

Figure 2. A comparison of the relationship between oxygen uptake and mechanical power output for two athletes. Though they have similar maximum oxygen uptake, their relative efficiencies in mechanical power production differ significantly.

The reasons for the large range in efficiency are not entirely clear. Certainly, a small part of the variability can be attributed to differences in the recruitment of auxiliary muscle groups not directly involved in mechanical power production. These muscle groups will demand oxygen, but will not contribute to the mechanical power output. The major part of the variability is probably a consequence of differences among individuals in the metabolic machinery, perhaps the content of certain enzymes responsible for muscle fiber contraction. In view of the wide range of efficiencies that we have observed, the distinction

that we have made between the physiologist's definition of "aerobic power" and mechanical power output is quite important, particularly since $\text{VO}_{2\text{max}}$ is frequently given as a measure of an athlete's performance. Although it was beyond the scope of our study, it would be particularly interesting to explore the potential for changes in efficiency in an individual, particularly as an indicator of level of training and perfection of technique.

Upright vs recumbent. A question about mechanical efficiency that concerned us and was not resolved by the literature was whether the semi-recumbent position entailed a lower mechanical efficiency than the standard, upright cycling position. The semi-recumbent position has significant advantages for human-powered aircraft because of the low frontal area of the pilot and the fact that the hands and arms have more freedom to manipulate flight controls. We therefore tested several of our athletes in both positions and a typical result is shown in Figure 3. We were able to find no significant difference in either maximum oxygen uptake or mechanical efficiency between the two positions. We were somewhat surprised that there was no difference in maximum oxygen uptake, because of the potential for upper-body-muscle recruitment in the upright position, particularly during the high-power portion of the test. Perhaps this can be explained by the fact that our subjects were experienced cyclists and they have optimized their pedaling motion for a wide range of power output.

HEAT, HYDRATION, AND FUEL

Heat dissipation, sodium, and water loss. A person's ability to dissipate the large amount of heat produced during heavy exercise is compromised by increasing dehydration. We calculated that a 68-kg pilot with a mechanical efficiency of 24% would produce about 900W of metabolic power during steady flight. Since only about 225W will be in the form of mechanical work, some 675W need to be dissipated through evaporative, radiative, and convective heat loss. The rate of heat loss from the body due to radiation and convection was estimated as 60W, assuming an average skin temperature of 33°C, a cabin temperature of 28°C, a total heat transfer area of 1.2 m², and a heat-transfer coefficient of 10 W/m²°C (Gagge, 1972). This leaves somewhat over 600W to be dissipated by evaporation of sweat. Taking the heat of vaporization

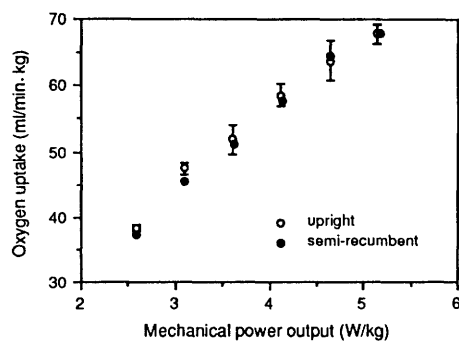

Figure 3. A typical comparison of oxygen uptake and mechanical power production for a single athlete in the upright and the semi-recumbent cycling position.

into account (0.7W per gram of water evaporated per hour) we estimated that the pilot will lose about 900 ml of water per hour. Since the ill effects of body dehydration begin to occur when the loss of body water exceeds 3% of body weight, the ability of the pilot to sustain flight depends upon the restoration of body water at a rate comparable to its loss. We assumed that the sodium concentration of the evaporated sweat was 20 meq/liter, in which case our pilots would also lose the equivalent of 0.4 grams of sodium per hour.

Fuel. The body's fuel stores contain a sufficient supply of potential energy to sustain activity for days, yet most of that fuel is in the form of triglycerides (fat), a form that is not metabolized at a great enough rate to provide all the energy needed for the Daedalus flight. The other fuel source is glycogen, the storage form of glucose (sugar), which can be transported and metabolized at the required rate. However, the amount of glycogen that can be stored in the liver and muscles is limited and would be depleted within approximately three hours of the start of exercise at 70% of maximum aerobic power (Coyle et al., 1986). The rate of depletion of glycogen stored in the body may be reduced by ingesting glucose during exercise and this phenomenon is exploited by endurance athletes who consume drinks or food containing glucose during exercise. To estimate the rate of glucose uptake by the body during flight, we assumed, from the data of Coyle et al., that the rate of glucose oxidation would be on the order of 50% of the total fuel-oxidation rate. Since the total oxidation rate yields an estimated 900 W, we used the energy conversion of 4.6 W per gram of glucose oxidized per hour to estimate that our pilots would

require approximately 100 grams of glucose per hour to fly the Daedalus aircraft.

The Daedalus drink. Our first approach to developing a drink to address the fuel and hydration problem was to conduct a literature search, including a comprehensive review by Murray (1987) of the characteristics and physiological effects of a number of carbohydrate-electrolyte drinks currently on the market. However, none of these drinks had sufficient carbohydrates and electrolytes to compensate for the losses we had estimated for the Daedalus flight. We proposed to rehydrate our pilots at the rate of one liter of fluid per hour and designed our drink with 10% glucose and 18 meq/liter sodium, concentrations estimated to replace glucose and sodium at rates equaling their losses. We tested the drink with four of our pilot-athletes during six-hour ergometer flight simulations at a mechanical power of 3.1 W/kg and found that blood glucose and hydration levels remained stable throughout the tests (Nadel and Bussolari, 1988).

CONCLUSION

As the technology of human-powered vehicles becomes more advanced, the challenge of long distances and durations push the limits of our knowledge of the physiological limits of exercise. The study that we have made of these limits was subject to the constraints imposed by the need to field an operational vehicle in a reasonable time period and therefore we have perhaps raised many more questions than we have answered. We have determined and demonstrated, however, that elite athletes are capable of maintaining a continuous mechanical power output at an oxygen uptake of 70% of their maximum for a period of greater than four hours, given proper supplementation with a glucose-sodium drink. Our flight simulations have demonstrated that an effort of 3.1 W/kg at the pedals may be sustained for six hours under the same conditions.

On April 23, 1988, Kanellos Kanellopoulos left the shore of Crete in the Daedalus aircraft. Nearly four hours later, after having flown 119 kilometers, he was forced into the water by gusty surface winds a few yards from the beach on Santorini. During the flight Kanellos drank almost four liters of the glucose-electrolyte drink. His heart rate never exceeded 142 beats per minute and at no time during the flight were there any signs of impending fatigue.

It is always tempting to speculate on the maximum duration possible for human-powered flight and, based upon Kanellos' effort, it is not difficult to project that he could have easily remained aloft for at least five hours and perhaps six, if the weather had been more cooperative and our goal more distant (he carried five liters of the energy-electrolyte drink on board). Durations of greater than that will certainly be possible if the specific power required of the pilot can be reduced. However, we find ourselves against an increasingly difficult weather barrier. Because of the size, speed, and low wing loading of human-powered aircraft, we will likely be able to fly only in very calm conditions (less than one or two knots (0.5-1 m/s) of wind) for some time to come. It is very difficult to find a geographical area in which one finds frequent occurrences of calm periods of that length, particularly over the kind of flat, featureless terrain that these aircraft are capable of negotiating. The biggest challenges of the future may be finding the patience to wait for the right day to make that once-in-a-lifetime very long flight.

REFERENCES

- Åstrand, P.-O., and Rodahl, K., 1986, *Textbook of Work Physiology*.
- Coyle, E.F., Goggan, A.G., Hemmert, M.K., and Ivy, J.L., 1986, "Muscle glycogen utilization during prolonged strenuous exercise when fed carbohydrate", *J. Appl. Physiol.* 61:165-72.
- Gagge, A.P., 1972, "Partitioned calorimetry in the desert", in *Physiological Adaptations*, ed. M. Yousef et. al., Academic Press.
- Murray, R., 1987, "The effects of consuming carbohydrate-electrolyte beverages on gastric emptying and fluid absorption during and following exercise", *Sports Medicine*, 4:322-51.
- Nadel, E.R., 1985, "Physiological adaptations to aerobic training", *American Scientist*, 73:334-43.
- Nadel, E.R., and Bussolari, S.R., 1988, "The Daedalus project: physiological problems and solutions", *American Scientist*, 76:351-60.
- Whitt, F.R., and Wilson, D.G., 1982, *Bicycling Science*, The MIT Press.

Steven R. Bussolari
Ethan R. Nadel
Lincoln Laboratory, MS PC-16
P.O. Box 73
Lexington, MA 02173-9108 USA

Editorials

(continued from page 3)

An unknown HP comes to light

HP 7/2 contained a brief index that I made from what I thought were all the issues from the start of the IHPVA. I had to rename and renumber some of the issues because of irregularities in the listed and actual publication dates. I was rather pleased with my work. It included a summer, 1979 issue that we classified as vol. 1 no. 3. However, no sooner was it published than Dan Hostetter of San Diego wrote to say that he had an additional issue named "summer, 1979" on the address page and "fall, 1979" on the front page. This was not listed on any publication list I had had, and as I was a founding board-member of the IHPVA I thought that I had everything. But what Dan was kind enough to send me was indeed an issue—a rather short but a good one—published between vol. 1 no 3 1979 and vol. 1 no. 4 1980. It has an article on how to join aluminum which we might repeat; a concluding article on an early Vector; and a nice review by Sandra Sims-Martin on the evolution of the vehicle that first reached 50 mph. (Her team was soon to achieve 65 mph).

What should we call the issue? 1/3.5? Or should we consider that it is just part of the earlier summer issue, 1/3/1979? Each has eight pages, so that the two together would not be too long at 16 pages. We'll decide after pondering all suggestions of solving this weighty problem.

Noise problems

Someone out there is creating a lot of noise, in the form of expensive packages sent by advertisers in *Forbes* and *National Defense Weekly* and delivered to IHPVA officers, including me. This person is filling in those handy postcards requesting further information on advertised helicopter gunships and the like, and putting down our names as potential future purchasers. One problem with this prank, apart from the waste of resources and the clogging up of my wastebaskets, is that I'm continually afraid that I'll miss a real contribution among all the junk mail coming to the editor of "Human Power Tech. Journal". We hope that the person who is doing this is confused rather than vindictive—the potential for serious damage to the IHPVA by someone who really wants to try is quite high.

Another problem is people with WATS or other low-cost long-distance telephone service. Some people tend to phone to leave messages on our answering machines requesting data that would take a considerable time to find, and request that we phone them back (at our expense). Usually no time at which the caller will be at the phone is suggested. After many times when I have done the requested research and then have not been able to reach the caller I have reluctantly decided to ignore such requests. It makes me feel guilty. And one has the feeling that one of them might be from a millionaire who would bestow a paid professional staff on the IHPVA. Forgive us!

—Dave Wilson



World record holder Gerhard Scheller with the Union Vector 007

The baking of the Bean

by Miles Kingsbury

It was about Christmas 1983 when I began thinking about a machine for the 1984 season. We had a very successful year pedal-car racing and there was no need to develop a new machine for a while. We therefore decided to concentrate on an out-and-out racer for sprints and high-speed circuit racing. However, after the relatively disappointing performance of [a machine called] the Trout, I decided to start afresh.

The machine that dominated the 1983 season was Bluebell (the fully-faired Avatar 2000) and I couldn't understand why. If the effective frontal area is the important thing, (drag coefficient \times frontal area) and the original Bluebell had more than its fair share of frontal area, then it must have a very low drag coefficient. I started thinking along the lines of a Bluebell-type machine but with reduced frontal area and maybe three wheels.

Starting with 1/5th-scale drawings a riding position was decided upon as shown in Figure 1. It was noticed that the three things that normally got in the way could be joined together with a nice straight line—the top of the head, the

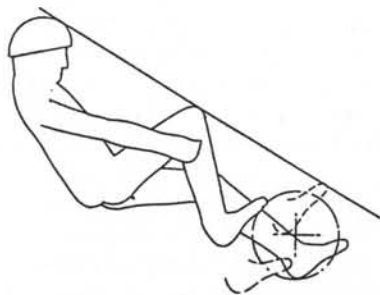

Figure 1. Head, foot and knee relationship

knee and the toe. This idea was expanded upon and the first 1/5th-scale model designed and is illustrated in Figure 2. This was done by taking sixty-five 4mm-thick horizontal sections through my 1/5th-scale drawing, each section being an aerofoil shape (from *Bicycling Science*). An aerofoil of about 25% thick seemed to fit best. Therefore, at the shoulders, where a width of about 18" (450 mm) was required, the length of the aerofoil would be six feet (1.8 m).

The 1/5th-scale model was made by cutting out the sixty-five section from 4mm-thick medium-density fibreboard (which is about halfway between chip-

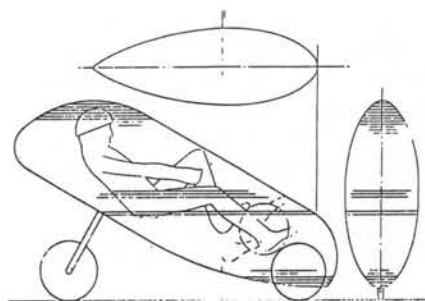

Figure 2. First model

board and hardboard), gluing them together and sanding down to get a smooth and very heavy plug. From this plug a glass-fibre mould was made, and from the mould two 1/5th-scale models.

The models were fitted with a nose wheel and an interchangeable rear support that could be fitted with one or two wheels. The rear section could also be adjusted to tilt the model from about 15 to 45 degrees to the horizontal.

One of the models was then taken to our tame aerodynamicist, Jeff Howell at Warwick University, where he set to work fitting it into their wind tunnel. Jeff is no stranger to HPV racing, having built two machines himself and evaluated the Dark Horse.

While Jeff was preparing one model, we set about building a large water tank out of benches and polyethylene sheet, with the aim of doing some drag tests ourselves. The wheels were fitted with ball bearings and the model was pulled through the water with constant force. It was timed across a set distance and the tilt angle of the model was varied. The conclusions drawn from the tests were that the water was very wet and cold and the tank was prone to sprout leaks. We dismantled the tank and waited patiently for Jeff to get some results.

There was great excitement when Jeff told us the first results. Predictably the model with two rear wheels had a relatively high effective frontal area of about 0.089 m² full size, but with a single rear wheel it was about 0.031 m² which is a lot less than anything else about (according to Chester Kyle's figures).

Without the rear wheel fitted, Jeff was able to establish that the effective frontal area fell to a minimum at a full-scale height of 1m. This gave a wind-screen angle of 15 degrees to the horizontal. There then followed some discussion about the aerofoil section that had been used. Jeff thought that the drag could be reduced still further by using a more

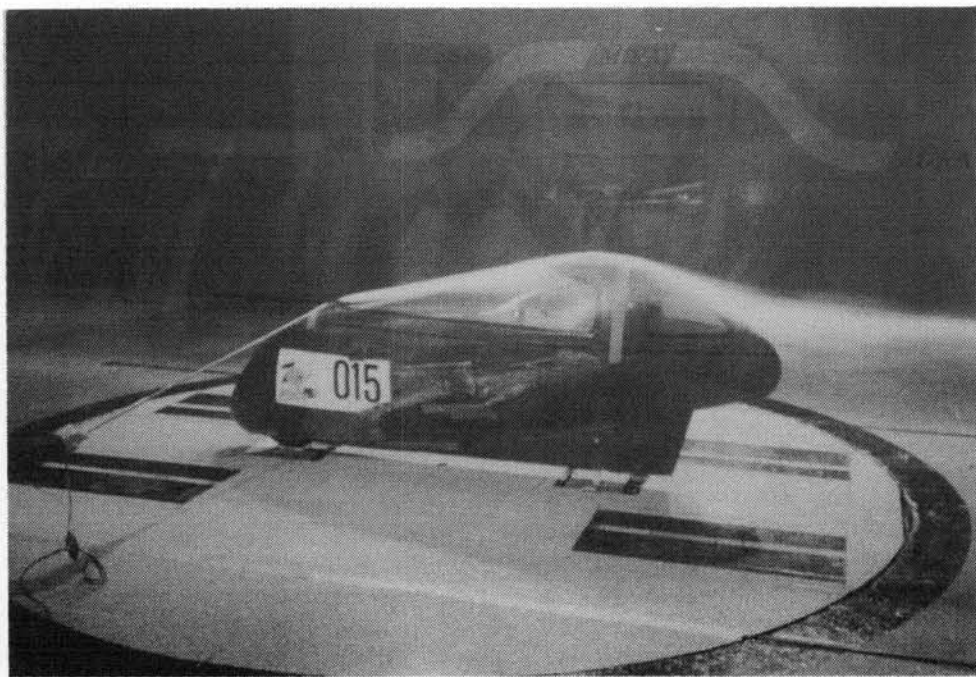

Wind tunnel testing of the Bean at MIRA

sophisticated section. He had two in mind, one being the NACA 66 wing section and the other a section designed for axi-symmetric bodies. The latter turned out to be rather too slender at the nose and tail, so an NACA 66.028 was chosen. (The last two digits are the percentage thickness, so that NACA 66.028 with a chord length of 100 mm would be 28 mm wide).

At this stage Jeff suggested that a 1/3rd-scale model would produce more accurate results, so I set to work. This time the vehicle could be designed knowing more or less that the screen angle would be 15 degrees to the horizontal giving an overall height of 1 m.

The second model was made in a similar fashion to the first, the only change being that this time seventy-four sections, each 6 mm thick, had to be cut out. This sounds a lot more time-consuming than it really was: to speed things up we built an adjustable pantograph. This meant the aerofoil had to be plotted only once and all other sizes could be scaled up or down from this one shape. A jig saw was used to do the cutting, with a vacuum cleaner attached to suck away the sawdust.

The plug was completed and two models taken from it. Jeff was given one of them and left to experiment.

Time was running out; MIRA was getting close (i.e., races at the Motor Industry Research Assoc.,—ed.) and there was little point in going for the DuPont Prize in the pedal car.

At this stage I had no idea of whether the machine was going to be rideable or not, as it had a very low seat height of about 250 mm. I drove up to the local dump and purchased a 14"-wheel kiddie's bike and proceeded to modify it into a tubular-steel-framed, single-speed, front-wheel-drive recumbent with an

adjustable rear wheel giving seat heights of between 250 mm and 400 mm.

It was 'built dirty', but finished in one weekend. The seat height was set to the minimum of 250 mm and after a few false starts, I pedalled off with remarkable ease. A couple of days later it was decided to test the device at 'speed' at a local industrial estate (park) where there is a half-mile section of road with a slight downhill gradient. I reached about 25 mph (11 m/s) which was not bad on a 50" (1.27 m) gear, and went home satisfied.

When the results for the second model came in we were delighted: the effective frontal area (full size) was down to about 0.025 m² at an overall height of 970 mm. This gives a drag coefficient of about 0.07 for a frontal area of 0.35 m². Wind tunnel data for both models is given in Figure 3.

The time had come to build the real thing—MIRA was only six weeks away.

This time there was very little to re-design. The height had to be reduced from 1000 to 970 mm and windows, central spine, seat, etc., added; the basic shape remaining the same.

The plug was made in the same way as the previous two, but this time there was the added problem of weight. There were seventy-four sections, each 19-mm thick. To reduce weight and cost, the middles were cut out of the larger sections and used for the smaller ones.

A very large pantograph was required this time along with three templates of various sizes. All the sections were glued together and the fin was fitted. The plug must have weighed about 300 kg. The next stage was to rub it down—this part alone took about three weeks of evenings and weekends. The surface was then sealed with polystyrene resin and polished to a shine. The plug was sawn in half and each half laid on aluminium sheet. The whole lot was waxed and applied with release agent. The mould was constructed with about 4 mm of glass fibre and a tubular-steel support frame to stand it on.

When the two moulded halves were removed from the plug, a number of air holes were found near the surface. These had to be filled and rubbed down, which was a week lost.

MATERIALS

It had been decided at an early stage in the project to make a sandwich-type construction using a pre-preg glass-fibre mat with an aluminium honeycomb to form the shell of the Bean. The shell was

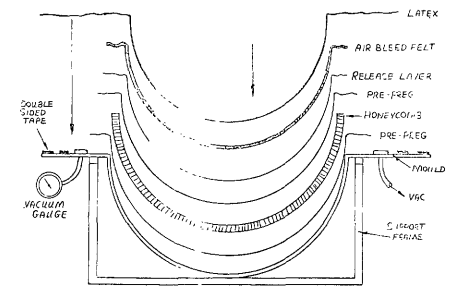

Figure 4. Mould layup stack

the main structure, the only other load-bearing member being the central spine. This was made from 10 mm-thick Fibrelam which is a glass-fibre-paper honeycomb sandwich used to make aircraft flooring. Figure 4 shows the mould layup stack.

The pre-preg (epoxy pre-impregnated fiberglass) sheet comes on a roll in an uncured state and has a similar feel to it as PVC sheet. To get its full mechanical strength, it has to be heated up to about 140°C for two hours.

To cure the pre-preg meant building an oven and this was done in the corner of a room using the walls and floor as three of the sides of the oven. The remaining walls and top were made from chipboard. The front section had three small windows in it and was removable. The oven measured 10 ft x 4 ft x 4 ft (3 m x 1.2 m x 1.2 m) and by experiment it was found that about 6 kW was needed to get the temperature up to 140°C. The main heat source was five cooker rings attached to one end.

Additional heat was provided by a number of spot lamps on the roof of the oven. Air was circulated using a 1/2-hp motor outside the oven, with an extended shaft and a 12" (300 mm) fan on the inside.

MOULDING

The moulding was done one half at a time. The pre-preg and honeycomb were laid into the mould as shown above, then the release layer, the air-bleed felt and finally the rubber. A vacuum was then pulled between the rubber and the mould. This was done using the inlet of a standard 1/2-hp compressor. A pressure gauge was also fitted to measure the vacuum.

The effect of the vacuum produced a pressure of about 10-12 psi (70 kPa) on the sandwich, ensuring a good bond between the three layers when the pre-preg cured.

In practice this part of the process turned into a new game—hunt the hiss.

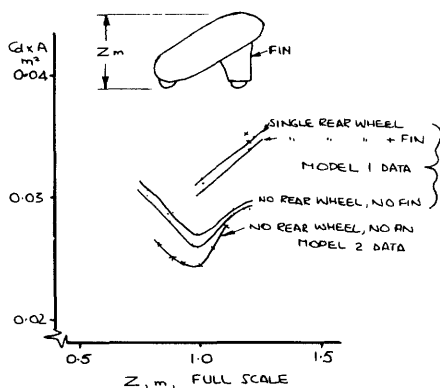

Figure 3. Wind tunnel data for both models

The moulds were rather porous, so it is just as well I don't build canoes. The moulds had to be stood on their sides and the backs painted with resin until the hisses had stopped.

Once a pressure of 300 mbar had been reached and maintained, the whole lot was put into the oven and the heaters turned on. This was a very worrying and exciting two hours, with one eye on the pressure gauge and one on the thermometer. The Bean began to cook.

The vacuum began to fail several times during the two hours, but fortunately it was traced to a leaky bit of double-sided sticky tape each time. It was a very unpleasant feeling flinging open the door and probing about in air at 140°C. Have you ever smelled chipboard at that sort of temperature?

Finally the two hours were up, the heat was turned off and the mould removed. Extracting the finished component from the mould proved to be rather more difficult than expected because the sandwich seemed to be acting as a capacitor. Huge sparks were jumping everywhere as the two parts were separated.

The next thing I did, as would any normal HPV builder, was to grab the spring balance—it weighed 7-1/2 pounds (3.4 kg) which seemed very good for half the structure.

Once the other half was complete, the two were taped together and a wooden mock-up of the seat and centre spine were made, to which a pair of conventional cranks and pedals were fitted. At this stage the canopy was not removable, so I had to climb in through the windscreen hole. Once inside I noticed that there was no room to spare anywhere, so the eventual positioning of all the components was extremely critical. After a few adjustments of seat angle and height, I was happy that everything would go in as planned. Now came the point of no return—to glue the two halves together.

The glue used was Redux 410, a two-part epoxy which was absolutely superb. It will stick just about anything and is particularly attached to the palette knife, which it glues to the floor, the table or the

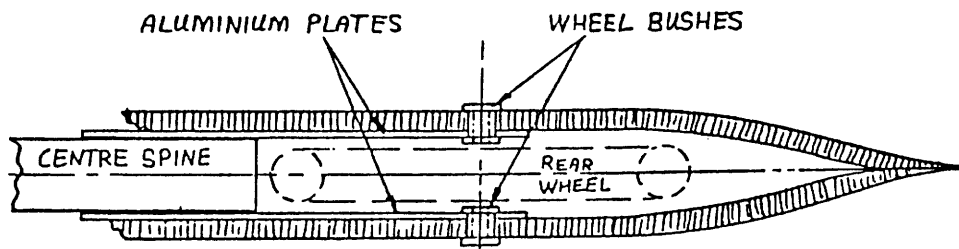

Figure 7. Section through rear-wheel fin

mixing bowl while you are admiring your handiwork.

The two halves of the shell were first trimmed and lightly sanded with glasspaper along with the edges. They were then taped back together and the glue was poured into the small gap from the inside. (The masking tape stopped the glue from oozing out and gave a neat joint.)

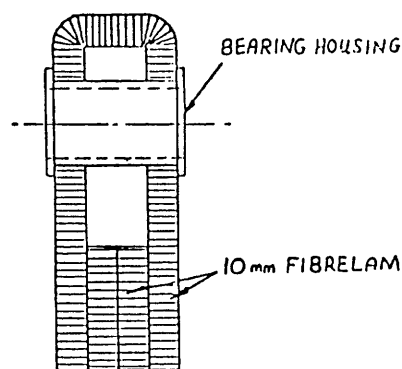

Figure 6. Cross-section of spine

When the two halves were stuck, the canopy was marked out, and sawn along the pencil line with a fine-toothed hacksaw blade. (The dust produced by the glass fibre was extremely irritating to the skin and whenever I worked with it I wore gloves, goggles and a mask.)

THE INNARDS

Now that the canopy was off, it was much easier to get at the inside of the shell and all the internal components could be fitted. The centre spine was the first to go in. This was constructed by folding 10-mm-thick Fibrelam to produce a deep 'U' section. As shown in Figure 5,

foldability is a very useful asset of Fibrelam. By cutting a length from one of the skins it is possible to produce a bend of a given angle with a nice radius on the outside.

The centre spine has to support the cranks, the crossover gearing and the front forks. The forks were fitted into an aluminium tube with a conventional headset; the other two parts were mounted to aluminium bearing housings. The housings and tube were glued into position when the spine was assembled. Figure 6 illustrates a cross-section of the spine.

The spine was then complete and ready to be fitted into the shell. It was designed to extend under the seat and locate accurately into the inside of the fin. Before it was fitted, two 2-mm-thick aluminium plates were positioned on either side of the fin. These were designed to spread the load of the rear wheel and are shown in Figure 7. The spine was then glued into position.

Next to go in was the seat which was made from Fibrelam. First a pattern was made from cardboard and the outside shape cut out. It was then folded and glued and the centre section removed for comfort. Kevlar cloth with a zip was then bonded to the front face. The zip was for access to the rear wheel. The seat is illustrated in Figure 8.

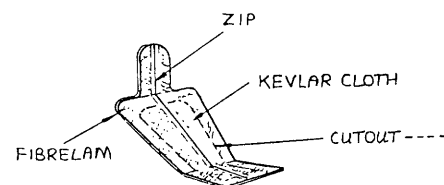

Figure 8. The seat



Figure 5. Folding Fibrelam

Finally, the front forks and drive chain were fitted. The front forks were made from Reynolds 531 with a standard crown and steerer tube. Campagnolo rear dropouts were used as a gear hanger was needed, and the forks spread to take a six-speed block, as shown in Figure 9.

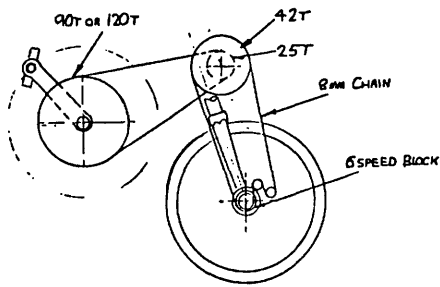

Figure 9. The drive chain

The wheels were based on standard 14"-diameter rims with our own design of hub. There were no spokes, but instead 24-swg aluminium discs were spun over the rim and glued to the hub.

Front-wheel drive was chosen to keep the rear of the machine clean, and also to reduce the amount of chain required. With 14" wheels, gearing was a problem. In order to get a top gear of about 200", a two-chain system was needed. The final drive relied on the chain being more or less parallel to the centre line of the forks. If it is not, then there will be a tendency to pull the steering to one side. The chain used was 8-mm-pitch industrial roller which is no lighter than standard 1/2"-pitch, but does make the chainrings and sprockets more compact. With the arrangement shown in the diagram above, the top gear is 200" with the 120T chaining fitted and 150" with the 90T.

Before the front wheel could be fitted, two cutouts had to be made. The smaller was to allow normal wheel movement, and the larger to enable the wheel to be fitted and removed. This larger cutout could also be used as ventilation during longer events. The two foot flaps were also cut out at the same time.

This just left the steering, which caused quite a few problems. It was decided not to try to design the levers and linkages until the vehicle was nearly complete. The original idea was to have a lever on each side of the driver which would be connected to the top of the steerer tube by a push-pull rod. This was tried but because the linkages could not be straight, the whole thing was too springy.

The second attempt at the steering was a central joystick which was connected to the steerer tube by a universal joint. It was made telescopic for safety. This arrangement was better but there didn't seem to be enough leverage.

By this time I was beginning to get a bit worried as I had still driven the Bean only about 50 yards without falling over.

The third and final version was based on the Avatar system with a pair of handlebars under the seat, connected to the steerer tube by a pair of Bowden cables. I thought the problem was solved until I tried it and still couldn't balance properly. The front-wheel drive was pulling the steering to the left and it was found that this was being caused by the chain being out of line. The size of the second drive sprocket was increased and the problem was solved. I could now stay upright for long periods at a time.

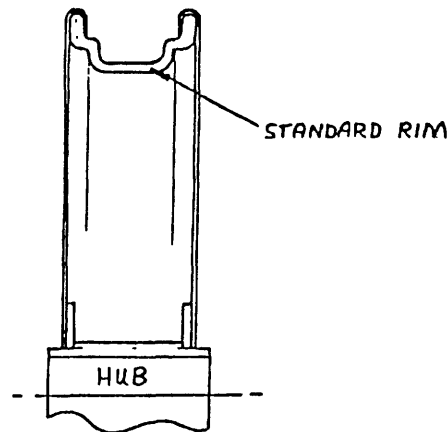

Figure 10. The wheels

TESTING

Getting going in the Bean has always been the greatest problem when it comes to testing. It is quite easy to start off by yourself without the canopy on as you can sit upright and move the torso about making balancing easier, but with it in position it is much more difficult. If you employ the help of someone to push you off, a lot of confusion can arise. For example, if you are falling in one direction, then you tend to steer into the fall—the pusher cannot understand why you are going off at 90 degrees. There is also a tendency for the pusher to give a little helping shove just as he or she lets go. The result in both cases is a horizontal Bean as demonstrated three times at Thamesmead.

Finding somewhere to practise has always been a problem with the high-speed machines as they are not really practical enough to use on open roads. The Bean's first test was at Slough Cycle Track which is concrete, 500 yards long and very bumpy. It probably had not been used for racing in about 20 years. After studying the local Ordnance Survey

map looking for nice straight and flat roads, a disused aerodrome at Chalgrove near Oxford was decided upon. It was a 2-1/2-mile perimeter road with one side very nearly a mile long. After some negotiations, permission was given to try it out.

We drove out to the aerodrome early one Saturday morning. I managed two laps of the perimeter track with the canopy off to have a look and get the feel of the surface. The track was generally good, but there were about six rather nasty bumps. I then tried the Bean out with the top on and got a shock—it didn't half go! I flicked through the gears and soon found myself cruising in a 150" gear with very little effort. I was doing 45 mph (20 m/s) down the straight and free-wheeling around the corners at well over 30 mph. The bumps made things very exciting, with both wheels leaving the ground by three or four inches. On the fifth lap I hit a large stone at about 35 mph and the front tire exploded, but I was able to park the Bean safely which was very reassuring. (The same thing happened to the rear wheel at a later date, and again I stopped safely.)

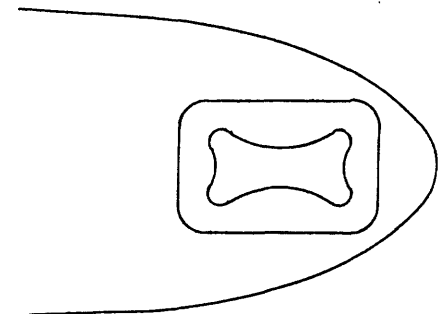
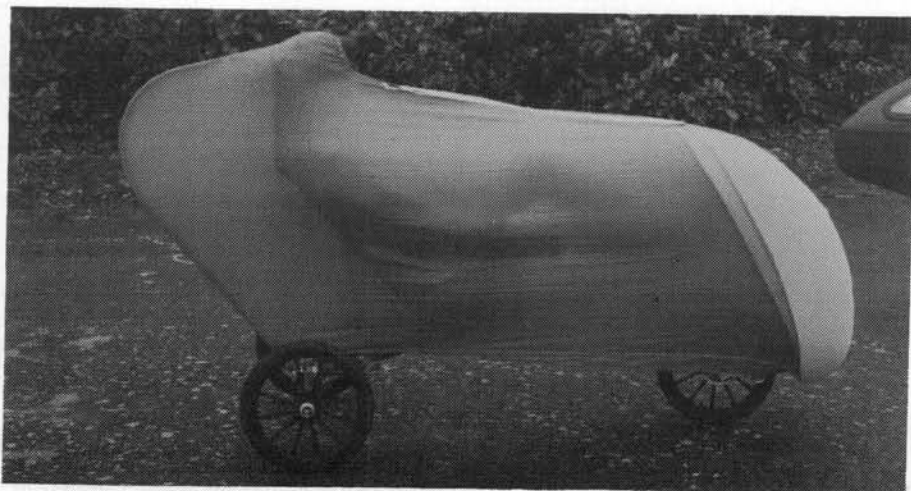

Figure 11. Front-wheel cutouts

RACING

The first outing for the Bean was to be Thamesmead which meant only two weeks left for finishing and further tests. At this stage the body shell was still in the 'natural' state—a dull yellow. It was sprayed and the go-faster stripes were stuck on the day before Thamesmead.

The weather was near perfect on the first morning of the sprints with hardly any wind—in marked contrast to the previous day. The first run was disappointing. I went through the gears too fast leaving me in top gear and pedalling much too slowly. I clocked 10.40 secs. for the 200 m giving a speed of 43.01 mph (19.3 m/s), putting me in fourth place. On the second run I didn't use top and it went much better. I took the lead with a



The Coffee Bean; a three-wheeler with front-wheel drive and steering

time of 9.69 seconds and 46.17 mph (20.6 m/s). On the third run I was caught by a gust of wind just before the timed section which took me by surprise. I eased off only momentarily, but it was enough to make a difference to my final speed. I clocked 9.73 seconds, a speed of 45.98 mph (20.55 m/s). By this time Doug Adamson in the Bluebell (Avatar) had done what had been expected of him and taken the lead back with a speed of 46.99 mph (21.00 m/s). This turned out to be the fastest run of the weekend.

I decided to sit out the round-the-houses road race as it was a bit twisty and I didn't like the look of the ramps over the pavement. As it turned out I was glad I did because it was a fantastic spectacle to see so many different types of machines thrashing through the corners at very high speeds.

When it came to the open road race on the second afternoon, I decided that four wheels were safer than two for myself and the Bean because of the wind blowing, so I raced in a pedal car which was hard work but very enjoyable.

Later in 1984 there were some more very close races between the Bean and Bluebell at Welwyn and Eastway, but we came out second on both occasions.

PLANS FOR THE FUTURE

A new Bean will probably be built which I am thinking of calling the Broad Bean as it will be slightly wider, and will then allow us to find a trained gorilla for a powerhouse.

The size of the wheels will probably be increased to 16" (406 mm) and more weight put on the front wheel, which should help the handling and improve traction as the front wheel tends to spin when starting off and going up hills.

The weight of the Bean is about 42 pounds (19 kg), but it is hoped to get this down closer to 30 pounds (14 kg). Most weight reduction will come from things like front forks and steel chainings and sprockets.

The stability of the Bean in cross-winds is extremely precarious at the moment, but it is difficult to know how to improve this. An extra two or three inches (50-75 mm) of ground clearance may well help and would definitely improve the driver's sense of balance.

As for new machines, I have some ideas and a completely new prototype which I am testing at the moment, but that is all I am going to say. You will just have to wait and see!

Miles Kingsbury
26 Dedmere Road
Marlow, Bucks SL7 1PG, UK.

(Miles' father John Kingsbury is secretary of the British Human-Power Club.) □

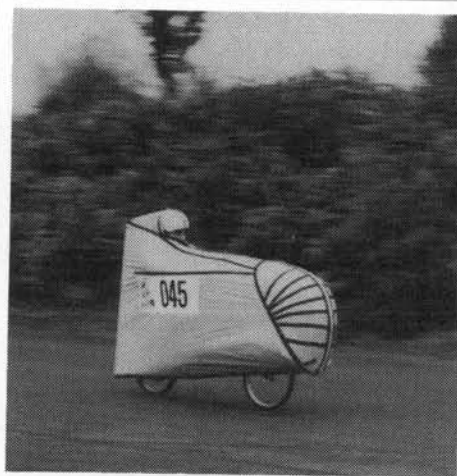

The Beanbag

Reviews

Designing and building composite R/C aircraft

You may wonder why we should review a book about model aircraft. There are two reasons. The less important is that it is written by Jack Lambie, co-founder of the IHPVA. The more significant is that it is full of information for designers and builders of aerodynamic shapes: the fairings by which we endow our vehicles with low resistance. Here are the principal chapter headings: basics of structures in model aircraft; performance and design; modern fun materials; foam/fiberglass technique; foam/fiberglass finishing; molds and near molds; composite paper models; composite model methods; safety; care and repair; and composite model kits. The style is direct, breezy and very practical; the hand-drawn illustrations are superb. I will use this book the next time I venture into the world of molding and shaping with plastics. The safety chapter is particularly valuable. Jack Lambie became, as I did, highly allergic to epoxy resins or hardeners, and graphically describes the effects. Do not proceed with anything until you have read this chapter. It's very important.

I bought my copy through Zenith Books, P.O. Box 1, Osceola WI 54020, phone 1-800-826-6600; book no. 112492AP, \$16.95 plus \$3.95 handling.

Bicycle sections to be established in libraries

This is the (abbreviated) title of a news release put out by The Bicycle Network and the indefatigable John Dowlin, Philadelphia (215-222 1253). He is trying to get more bicycle materials into public libraries, and was offering a package at cost for National Bike Month (May). "Walk into any library and ask to see what they have on automobiles, and then on bicycles, and you'll see a discrepancy that's not unlike city traffic... Our libraries are indeed 'car friendly', but this imbalance could be easily corrected."

If every member of the IHPVA did likewise and asked the librarian to stock HPV News and Human Power, and if only one-quarter responded positively, the visibility and accessibility of the human-power movement (including bicycles) to lay people, especially youngsters, would be greatly enhanced. Please try it!

Ties—Technology, Innovation and Entrepreneurship for Students

TIES is the title of a nicely produced Drexel University magazine for students. Marti Daily contributed a exciting survey, with excellent colored photos, of recent IHPVA activities in the January/February 1989 issue, emphasizing the entries from schools and colleges. Chet Kyle followed this with "Designing efficient HPVs", and there was a third HPV article, to tap the humanitarian impulses of constructors, about the work of Ken Hughes and the Institute for Transportation Development that, among other things, supplies bicycles to Africa, Latin America and other Third-World areas.

Designing and building the three-wheeled human-powered vehicle

by Tom McGriff and Jim Wolpert

The designers of Hudyn Vehicles have put their thoughts, opinions and some of their secrets down on paper in a well-illustrated and racy written book-report. They take the would-be designer through the stages from initial concept to final construction. They force the reader to ask questions to ensure that s/he has thought through the real purposes of the effort. They discuss the principal alternatives at every stage.

I heartily recommend this book to all enthusiasts starting on three-wheeled HPVs. I saw an early edition of the book and found some places where I would have recommended differently (for instance, I believe that a general-arrangement drawing should be made before detail sketches) but I know that revisions and corrections have been made in later versions. I don't know the price and availability: write to Tom McGriff at P.O. Box 22444, Indianapolis, IN 46222.

Alternate Energy Transportation

This newsletter reports that GM has announced "GM Sunrace USA" for solar-powered vehicles from Florida, July 8, 1990, to the GM Technical Center in Detroit, for 32 N. American schools and colleges. The winners will be awarded an expense-paid trip to Australia to compete in the 1990 World Solar Challenge (qv, below). Proposals should go to GM Sunrace USA, Proposal Review Committee, 825 Myrtle Avenue, Monrovia, CA 91016 (AeroVironment).

The *World Solar Challenge* will start in Darwin, Australia on November 25, 1990. The AET editor had some influence in scheduling the International Electric

Vehicle Symposium, EVS-10, to be held in Hong Kong, so that people could attend both events. However, the current schedule, December 3-5, would not allow late finishers time to get to Hong Kong, and the editor is asking for EVS-10 to be held just before the race. □

Letters to the Editor

(continued from page 4)

Stability or control?

In HP 7/3, Doug Milliken describes some fascinating experiments, and then suggests that control is more important than stability—but there really is no contradiction. Statements such as "... is the condition required for stability" or "... vehicle configuration is unstable" are incomplete. For completeness, the question of stability or instability must always be associated with a particular dynamic mode of motion, with input and output variables defined.

Regarding page 9, center column, fourth paragraph, the "aerodynamically stable" configuration with center of pressure aft of center of gravity comes from an analysis in which steer angle is held constant, very similar to the analysis which requires the neutral steer point to be aft of the CG to avoid oversteer. Thus, it is more complete to say that the CG of a (multitrack) vehicle must be forward of the CP for a vehicle with fixed steer angles to remain on its path in crosswinds. If steer angle can vary, the above stability analysis is less relevant, and a complete stability analysis would include the rider's control response to the side force. Without pretending to understand their results completely, I note that the external side force can be cleanly cancelled if it is applied near the steered wheel, ie at the head tube, so Doug's and Max's observations make sense and do not particularly contradict the constant-steer-angle stability analysis.

In the same issue, Robert Price's article makes an erroneous statement on page 20, first column, last paragraph. A car's pivot point during cornering lies on an extended line which originates between the CG and rear axle only below about 10 m/s. At faster speeds, the pivot point moves forward, even well beyond the extended front axle line. Thus the rear wheels always have a greater turning-circle radius during high-speed cornering,

so figure 11 is correct for front steering only at low speed.

John C. Whitehead
JCW Engineering
3322 Biscayne
Davis, CA 95616 USA

(Doug Milliken responds: "Thanks to John Whitehead for clearing up an area that I'd left slightly vague in my article" From Rob Price: "Mr. Whitehead is correct in that after about 10 m/s (25 mi/hr) the steering pivot point moves forward from between the c.g. and rear-axle centerline as shown in the car case in Figure 10. Just where the pivot point will be at any instant is dependent primarily on sideward tyre loading, which is a function of vehicle speed and the radius of the turn. Generally when the pivot point moves forward of the front axle the driver has established what is known in automobile racing as a 'four-wheel drift' or just 'drift.' It requires careful power regulation and skillful minute steering inputs to maintain this condition through a turn. It takes considerably more power than can be generated by a human to maintain a drift, unless on ice or loose dirt, and is a condition which would be anomalous if encountered in an HPV, so does not need to be designed for.

Figure 11 does illustrate the slow-speed case for the bicycle. The rear wheel will track with or outside the front wheel during hard cornering, as Mr. Whitehead states, but if the steering pivot point moves forward of the front-wheel centerline, establishing the machine in a drift as described above, chances are great the bicycle is about to crash!")

Recumbents and suspension

Regarding Rob Price's article in HP 7/3 on steering and suspension design, could we get someone to write on how to build a simple recumbent-bicycle frame, and a simple suspension system? I have seen everything from fancy systems like the Moulton to springs—or even bungee cords—on a modified fork. I have also seen rear suspended frame triangles using both springs and bungees, as on the Bowerbike. I figure, as a nontechnical person, I may be able to build one, but designing is another matter altogether. (I get so much out of HP articles and I really appreciate the knowledgeable authors for taking the time to write. Thank you!)

Robert J. Bryant
16621 123rd Ave, SE
Renton WA 98058 USA

(*Mea culpa!* See my note re Werner Stiffel's article—ed). □